

# ALINCO

DIGITAL MULTI-MODE RECEIVER

# DJ-X100T/E

## Instruction Manual

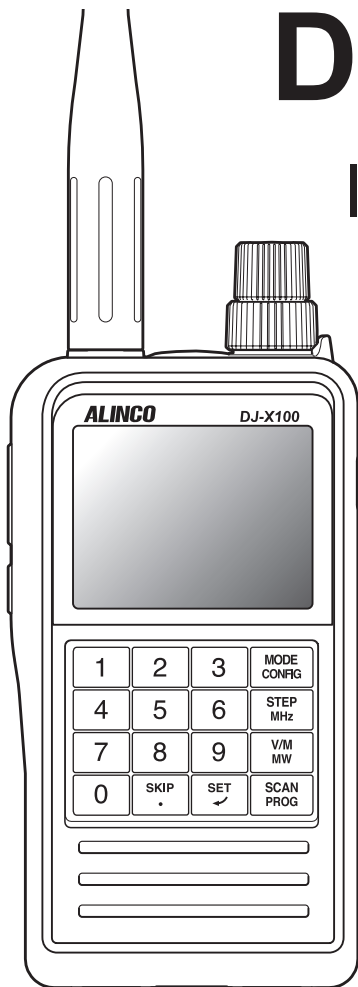

This device complies with Part 15 of the FCC Rules. Operation is subject to the following two conditions: (1) This device may not cause harmful interference, and (2) this device must accept any interference received, including interference that may cause undesired operation.

CAUTION: Changes or Modifications to this device, not expressly approved by Alinco, Inc., could void your authority to operate this device under FCC regulations.

MODIFICATION OF THIS DEVICE TO RECEIVE CELLULAR

RADIOTELEPHONE SERVICE SIGNALS IS PROHIBITED UNDER FCC RULES AND FEDERAL LAW.

It's illegal to intentionally intercept or attempt to intercept electronic communication and to use or disclose information obtained through receiving electronic communications, moreover, possession and use of communications receivers is prohibited in many countries.

Please check your local Radio Law and Privacy act about use of receivers in advance to purchase this product.



Thank you for purchasing your DJ-X100T/E. Please read this manual carefully before using the product to ensure full performance, and keep this manual for future reference as it contains information on after-sales service.

In case addendum or errata sheets are included with this product, please read those materials and keep them together with this instruction manual for future reference.

# ALINCO, INC.

# ◆◆◆WARNING◆◆◆

To prevent any hazard during operation of Alinco's product, in this manual and on the product you may find symbols shown below. Please read and understand the meanings of these symbols before starting to use the product.

Symbols	Definitons
 <b>Danger</b>	This symbol is intended to alert the user to an immediate danger that may cause loss of life and property if the user disregards the warning.
 <b>Alert</b>	This symbol is intended to alert the user to a possible hazard that may cause loss of life and property if the user disregards the warning.
 <b>Caution</b>	This symbol is intended to alert the user a possible hazard that may cause loss of property or injure the user if the warning is disregarded.

## ■Common (Radio/Battery/Charger/AC Adapter)

### **Danger**

- ⊙ **Do not operate the radio, disassemble or charge the battery in the potentially flammable and explosive atmosphere ( such as gas station, coal gas station, etc).**  
This product is not anti-explosive.
- ⊙ **Failure to observe the following precautions may cause an accident that could lead to fire, overheating, electric shock, injury, or equipment malfunction.**
  - Do not use third party AC adaptor, Battery and Charger.
- ⊙ **Do not place under direct sunlight high temperature and close to air conditioner and fire.**  
Exposure to direct sunlight in enclosed areas such as a car interior or near windows, even during winter, may cause overheating, leading to battery pack rupture, fire, or equipment malfunction. Even mild warmth from air conditioning or heating systems can contribute to elevated temperatures if continuously exposed.

### **Alert**

- ⊙ **Do not disassemble or modifying the product the radio.**  
It may result in fire, electric shock, or equipment malfunction.
- ⊙ **In case of abnormalities such as smoking, unusual smells, strange noises, or swelling, please refrain from using the product.**  
Continued usage may lead to fire, electric shock, or equipment malfunction. Immediately turn off the power, remove the battery from radio, unplug the AC adapter from the AC outlet if using a charger, and ensure that smoke has stopped before contacting your distributor.
- ⊙ **Use and store in a location out of reach of children.**  
It may cause electric shock or injury.
- ⊙ **Prevent from bending, twisting, pulling, or placing heavy objects on the power cable.**  
Damage to the power cord may result in fire, electric shock, burns, or injury.

 **Caution**

- ⦿ **Do not place it on unstable surfaces such as wobbly tables or inclined areas, or in places with excessive vibration.**  
Dropping or tipping over may result in fire, injury, or equipment malfunction.

**■ Radio** **Alert**

- ⦿ **Do not shaking and throwing the product.**  
Dislodged components may cause injury, damage, or malfunction if they hit people, walls, or other objects.
- ⦿ **Do not use this product without permission in places where the use of electrical appliances is restricted, such as on an aircraft.**  
Doing so may cause a safety hazard. Do not turn on the power until you have permission from the administrator of the place where you will be using the product.

 **Caution**

- ⦿ **The manufacturer declines any responsibilities against loss of life and property due to a failure of this product when used with or as a part of a device made by third parties.**
- ⦿ **The radio should be used in an ambient temperature.**  
It may result in malfunction, operational issues, or overheating leading to fire.
- ⦿ **Be aware of loud audio while using earphones.**  
Listening at high audio level for long time may cause damage to your ears.

## ■ Optional Accessory : Charger, Charger Stand

### Alert

- ⦿ **Failure to observe the following precautions may cause an accident that could lead to fire, overheating, electric shock, injury, or equipment malfunction.**
  - Do not operate this product in a wet place such as in a shower room.
  - Never touch outlet and charger with a wet hand. It may result in electric shock.
  - Do not insert metallic objects into the charging terminal.
  - Do not install in a humid, dusty or insufficiently ventilated place. It may result in electric shock.

### Caution

- ⦿ **Failure to observe the following precautions may cause an accident that could lead to Liquid leakage, or equipment malfunction.**
  - The ambient temperature should be between (50° - 104°F) in charging. Charging outside this range may not fully charge the battery.
  - Do not install in a humid, dusty or insufficiently ventilated place. It may result in electric shock.
  - Unplug the AC adapter after charging or when not in use.
  - Do not use chargers other than having the specified voltage. Never turn on the radio while charging.

## ■ AC Adapter, USB Adapter

### Alert

- ⦿ **Never touch adapter with a wet hand.**

It may result in electric shock.
- ⦿ **Do not use adapter when a power cord (including USB cables and adapters) is damaged.**

It may result in electric fire, electric shock or mal function.
- ⦿ **Failure to observe the following precautions may cause an accident that could lead to fire, overheating, electric shock or injury.**
  - Do not use the adapter if the plug or socket contacts are dirty. Overheating and/or short-circuiting may result in fire, electric shock and/or damage to the product.
  - Never pull the cord alone when you unplug USB cable form the wall outlet.
  - Do not place heavy object on the cable.
  - Do not bend, twist, pull or heat the cable.
  - Do not use the cable in wet conditions.
  - Do not use in a humid, dusty or insufficiently ventilated place.

## ■ Battery

### Danger

- ⦿ **Never use, charge or exposure to direct sunlight in enclosed areas such as a car or near windows, may cause overheating, leading to battery rupture, fire, or equipment malfunction.**

The performance and lifespan of the battery pack may deteriorate, and the protection circuit may activate, preventing charging. This can lead to rupture, smoking, ignition, fire, liquid leakage, or burns. Exposure to direct sunlight in enclosed areas such as a car interior or near windows, even during winter, it may rise to dangerous temperatures.
- ⦿ **Do not drop the battery onto hard surfaces like concrete, give it to strong impacts, or throwing it.**

Even if there are no visible cracks or damages on the exterior, internal damage may occur. Continuing to use it in this condition may lead to rupture, ignition, fire, overheating, or smoking.
- ⦿ **Failure to observe the following precautions may cause an accident that could lead to fire, overheating, electric shock, injury, or equipment malfunction.**
  - Never throw the battery into fire, and heat it.
  - Do not immerse or wet the battery in liquid.
  - Stop using the battery immediately and remove it from the receiver if it swells. Please dispose of it in a battery recycling box.
  - Do not solder at the battery terminal.
  - Do not connect between battery packs and the terminal using with metal.
  - Do not leave metal objects (such as wires, necklaces, keys, etc.) or conductive items on top of the battery pack, and avoid carrying them together.
  - Do not rub if battery electrolyte contacts the eyes. There is a risk of blindness. Immediately rinse with clean water and seek medical treatment.

### Caution

- ⦿ **Replace battery pack if the available usage time becomes shorter or after prolonged usage.**

It is recommended to replace it within approximately 3 years, and at the latest by 5 years. Continuing use beyond this period may lead to smoking or fire.
- ⦿ **Stop using radio if it is heating up more than usual during use or while charging,**

It may lead battery packs to rupture, overheating, leakage of liquid, malfunction. Please dispose of it in a battery recycling box.

## Caution

⊙ **Failure to observe the following precautions may cause of leading to overheating, liquid leakage, corrosion, decreased performance, and reduced lifespan.**

- Do not leave the battery pack fully charged or completely depleted for long time.  
When storing the battery pack for long time, discharge it completely, then recharge it to approximately half of the estimated full charging time.
- Always turn off the power when the receiver is not in use.
- Always remove the battery pack from the receiver when storing it. Leaving it installed may lead to over-discharge, rendering it unable to charge.

### **The characteristics and lifespan of the battery pack.**

- ⊙ Battery pack is a consumable. The estimated number of charge cycles is between 300 to 500 times.  
Regularly check the charging status. If you notice any abnormalities such as excessive heat or swelling, discontinue use of the battery pack.
- ⊙ Even when stored without use, deterioration progresses.  
Once deterioration begins, even from a fully charged state, operational time may decrease.
- ⊙ Deteriorated battery packs may cause ignition or fire, so do not use them. We recommend replacing them within approximately 3 years, and no later than 5 years, for safety reasons.

## **Electromagnetic noise**

In electronic devices that incorporate inverter circuits, as well as in the interiors and surroundings of hybrid cars and electric vehicles, electromagnetic noise may affect reception, causing interference and potentially disrupting normal operation.

### **Main electronic devices incorporating inverter circuits**

- LED lighting devices
- Induction cookers
- Water heaters
- Automotive electronic devices
- Solar power generation systems, etc

## ◆◆◆◆ Precautions before use ◆◆◆◆

### Handling Request - Please read carefully.

**This document contains important information that you should pay special attention to when using this product. Please be sure to read it carefully. Incorrect use may void the product warranty or lead to troubles and malfunctions.**

- When using the receiver near facilities catering to accommodations, or amusement areas, there is a risk of being misunderstood as eavesdropping, leading to trouble. Some places such as theme parks, amusement areas, and concert halls may prohibit the entry of receivers. Please promptly comply if instructed.
- Do not remove or cover the black circular seal attached to the back of the main unit with another label. Doing so may compromise the waterproofing performance, alter the internal pressure, and cause changes or loss of sound from the speaker.
- The manufacturer declines any responsibilities against loss of life and property due to a failure of this product when used with or as a part of a device made by third parties.
- When using outdoors, be sure to use earphones or a headset. Not only can loud noises be a nuisance, but if you allow a third party to listen to communications that are not related to you, you may be punished for breaching confidentiality.
- Do not use the receiver as part of any system or electronic device without prior individual agreement. We cannot accept any responsibility for malfunctions, defects, or damages unless there is a prior individual agreement.
- Use a clean, dry cloth to wipe off dirt and condensation from the surface of the product. Never use thinner or benzene for cleaning.
- Clean terminals between the main unit and accessory charging stand with a dry cotton swab. Dust and dirt can cause charging problems.
- Never remove, cover, or replace any labels, including those containing the model name, numbers, or symbols. It may result in the product being considered stolen or illegally modified, leading to exclusion from our product warranty and service.
- Be cautious of a dew formation. Never turn on, and completely dry the product before use when it happens.
- Batteries have reduced temporary usability in high or low-temperature environments, and prolonged exposure can accelerate battery degradation. Please store them in a case or similar to keep them close to room temperature for optimal performance.
- Use reliable quality alkaline batteries when using optional battery cases. Manganese batteries, nickel-metal hydride rechargeable batteries, and low-quality batteries may result in shorter operational time and malfunction. Never use disposable AA Li-Ion batteries. as they may cause malfunctions due to their high initial voltage.
- Be cautious of the whip antenna when carried in your shirt-pocket etc. It may make contact with your eye and cause injury.
- Carrying the product with the antenna, bending, twisting, or applying pressure to it may cause malfunction.
- For safety, always turn off the power to the main unit, remove the batteries, and unplug any adapters from the AC outlet when doing maintenance.
- Broadband receivers may have frequencies where reception is impossible or noise is generated due to internal oscillation (spurious). This is not a malfunction.

- ⊙ Even when not in use, store it in a well-ventilated area and power it on occasionally. Prolonged storage can lead to deterioration of the battery as well as degradation of rubber and plastic components through hydrolysis, causing them to become brittle or discolored.
- ⊙ Using it near electrical and electronic devices such as TVs, radios, LED lights, solar panels, computers, car navigation systems, and other automotive equipment may result in electromagnetic interference, such as noise.
- ⊙ Placing it in pants pocket and using it may subject it to excessive force when sitting, leading to malfunction and damage.

#### **[Use while driving]**

- ⊙ It is recommended that you check local traffic regulations regarding the use of a radio equipment while driving. Some countries prohibit or apply restrictions for the operation of radios and mobile phones (cell phones) while driving.
- ⊙ Do not drive while in a condition that external sounds cannot be heard. Connecting external amplifiers or large speakers and receiving at high volumes that prevent hearing surrounding sounds, or using headphones that completely cover the ears, may result in penalties. Some local governments regulate the use of earphones or headphones while driving, so if you have any questions, please inquire at your nearest police station or relevant authority.
- ⊙ Do not drive while wearing the receiver clipped to your body with a belt clip or similar attachment. Antennas or accessories may get caught and obstruct driving. Being distracted in this way can lead to inattention while driving.

#### **[Caution for recharge]**

- ⊙ When charging, you may fluctuate in the S-meter or hear noise due to noise entering from the power line.
- ⊙ Always turn the radio off to completely charge the battery. Charging may not proceed correctly if the power remains on.
- ⊙ The charging time and usage with a portable battery vary depending on its battery capacity.

#### **[For IP67]**

IP6X: Dust tight / No ingress of dust; complete protection against contact. Test duration of up to 8 hours based on air flow using specified powders.

IPX7: No water penetration / Submerge the device for 30 minutes at a depth of 1 meter from the fresh water's surface.

The IP67 designation provides for limited dust and fresh water proofing of the radio, antenna and battery pack when integrated, as specified above. This compatibility is factory guaranteed for a period of one year provided all specified conditions of use are respected, any accessories connected must be specified genuine Alinco accessories and the device has not been disassembled by the consumer. The device is designed to remain operational when used in rain, severe weather or in accidental cases of dropping it in wet place when used in extreme conditions and is in no way stating that you should attempt to use the device under water or submerge the radio for cleaning. Warranty will not cover devices that are damaged due to negligence or misuse of the product. Never remove the small label attached on the rear chassis of this product, or cover it with other materials. This label is essential to adjust an air pressure inside to secure dust/water proofing. A periodical, professional maintenance is recommended when the ingress protection is very important to you.



Note: This model only waterproof when MIC-SP jack cover is tightly closed to body.

### [Lightning]

Any person is not safe outdoor during thunderstorm and lightning. This condition is getting worse if somebody keeps a handheld radio; chances of being hit by lightning are doubled since lightning may hit a radio antenna as well. At this time, there is no handheld radio having any kind of protection against lightning current (which is higher than 10 kA.). Note also that no car provides adequate protection of its passengers or drivers against lightning as well. Therefore, Alinco will not take responsibility for any danger associated with using its handheld radios outdoor or inside the car during lightning.



### [Disposal]

The crossed-out wheeled bin symbol on your product and documents reminds you that in the EU, all electrical and electronic products, batteries, and rechargeable batteries (accumulators) must be taken to designated collection locations at the end of their working life. Do not dispose of these products as unsorted municipal waste, but dispose of them according to the laws in your area.

### [Trademarks / Copyrights / Patents]

Alinco, Inc., Alinco, and the Alinco logo are registered trademarks of Alinco, Inc. The patents for receiving D-STAR signals are used under license from Icom Incorporated. NXDN is a registered trademark of Icom Incorporated and JVCKenwood Corporation, and DMR is a registered trademark of the DMR Association, which we are licensed to use. Microsoft and Windows are registered trademarks or trademarks of Microsoft Corporation in the United States and other countries. C4FM is a communication mode for amateur radio recommended by Yaesu Musen Co., Ltd. dPMR is a trademark of the dPMR MoU Association. Other company names and product names mentioned in this document are trademarks or registered trademarks of their respective companies. Trademark symbols (™ or ®) are omitted in this document.

This receiver adopts DVSI Vocoder device to decode AMBE digital signals therefore not subject to patents and licensing.

Information in this document is subject to change without notice or obligation. All brand names and trademarks are the property of their respective owners. Alinco cannot be liable for pictorial or typographical inaccuracies. Some parts, options and/or accessories are unavailable in certain areas. Changes or modifications not expressly approved by the party responsible for compliance could void the user's authority to operate the equipment.

### NOTICE / Compliance Information Statement

This equipment has been tested and found to comply with the limits for a Class B digital device, pursuant to part 15 of the FCC Rules. These limits are designed to provide reasonable protection against harmful interference in a residential installation. This equipment generates, uses and can radiate radio frequency energy and, if not installed and used in accordance with the instructions, may cause harmful interference to radio communications.

However, there is no guarantee that interference will not occur in a particular installation. If this equipment does cause harmful interference to radio or television reception, which can be determined by turning the equipment off and on, the user is encouraged to try to correct the interference by one or more of the following measures:

- Reorient or relocate the receiving antenna.
- Increase the separation between the equipment and receiver.
- Connect the equipment into an outlet on a circuit different from that to which the receiver is connected.
- Consult the dealer or an experienced radio/TV technician for help

Changes or modifications not expressly approved by the party responsible for compliance could void the user's authority to operate the equipment.

This device complies with Part 15 of the FCC Rules. Operation is subject to the following two conditions:

(1) this device may not cause harmful interference, and (2) this device must accept any interference received, including interference that may cause undesired operation.

This device contains licence-exempt transmitter(s)/receiver(s) that comply with Innovation, Science and Economic Development Canada's licence-exempt RSS(s). Operation is subject to the following two conditions:

- (1) This device may not cause interference.
- (2) This device must accept any interference, including interference that may cause undesired operation of the device.

L'émetteur/récepteur exempt de licence contenu dans le présent appareil est conforme aux CNR d'Innovation, Sciences et Développement économique Canada applicables aux appareils radio exempts de licence. L'exploitation est autorisée aux deux conditions suivantes :

- (1) L'appareil ne doit pas produire de brouillage;
- (2) L'appareil doit accepter tout brouillage radioélectrique subi, même si le brouillage est susceptible d'en compromettre le fonctionnement.

 Tested to Comply  
With FCC Standards  
FOR HOME OR OFFICE USE

#### **About CE and DoC**



Hereby, Alinco Inc. declares that DJ-X100E which has the "CE" symbol on the product, complies with the essential requirements of the Radio Equipment Directive 2014/53/EU, and the restriction of the use of certain hazardous substances in electrical and electronic equipment Directive 2011/65/EU.

The full text of the EU declaration of conformity is available at the following address: <https://alinco.com/Ce/>

# ◆◆◆ Table of Contents ◆◆◆

<b>WARNING</b> .....	<b>2</b>
<b>Precautions before use</b> .....	<b>7</b>
<b>Table of Contents</b> .....	<b>11</b>
<b>Functions and Features</b> .....	<b>17</b>
<b>1. Before use</b> .....	<b>18</b>
Check accessories .....	18
Attach / Detach Accessory.....	18
Antenna EA-295 .....	18
Belt clip EBC-65 (Belt clip x1, Screws x2pcs) .....	19
LI-ion battery pack EBP-114A .....	19
Attach Battery Pack.....	19
Remove Battery Pack .....	20
Optional Dry Cell Battery Case EDH-46.....	20
Estimated operating hours for battery pack and dry cell battery case .....	20
Prevent Short Circuiting from the Battery Pack.....	21
Battery Information .....	21
How to recharge Li-ion battery pack.....	22
USB adapter.....	23
Optional accessory: EDC-325.....	24
Battery Icon .....	25
Battery level .....	25
During the charge.....	25
<b>2. GETTING ACQUAINTED</b> .....	<b>26</b>
Main unit.....	26
Top and front .....	26
Side .....	27
Display example.....	27
Key operation .....	29
<b>3. BASIC OPERATIONS</b> .....	<b>31</b>
Turning the Power On and Off.....	31
Adjusting the Frequency.....	31
Setting the Frequency with the Dial. ....	31
Entering Frequencies Directly .....	31

- Adjusting the Volume..... 32
- FUNC (Function) Key Operations ..... 32
- Squelch level and S-meter ..... 33
  - About squelch ..... 33
  - About S-meter ..... 33
  - About [BUSY] icons..... 34
- Monitoring Function..... 34
- Selecting Receive Mode..... 34
  - Analog ..... 35
  - Digital ..... 35
  - Data..... 35
- Receiving Communications..... 35
- 4. OPERATION MODE..... 36**
- The Receiver’s Automatic signaling Analysis Function ..... 36
- Switch the Operation Mode ..... 37
- VFO Mode ..... 37
  - Select the Frequency Step..... 37
  - 1MHz Up/Down ..... 38
  - 10-Fold Frequency Steps..... 38
- VFO Scan Mode..... 39
  - Type of Scan ..... 39
- VFO Scan..... 39
  - Common Scan Operations..... 40
  - All Scan ..... 40
  - MHz Scan..... 40
  - Program Scan ..... 41
- Registering Program Channels ..... 41
  - Start Frequency..... 41
  - End Frequency..... 41
  - Link Scan ..... 43
  - Priority Scan..... 45
  - Shift Scan..... 45
- Skip ..... 46
- FM Radio Mode..... 47

<b>5. MEMORY MODE.....</b>	<b>49</b>
Types of Memory and How to Use Them .....	49
Registering Memory Channels .....	49
Deleting Memory Channels .....	55
Operating Memory Mode.....	56
All Memory .....	56
Bank .....	56
Bank Link .....	56
GPS Memory.....	57
Memory Name .....	59
How to Edit Memory Names .....	59
List of Entry Characters.....	60
Enterable Characters .....	61
Memory Scan .....	62
All Memory Scan.....	62
Bank Scan.....	62
Bank Link Scan .....	62
GPS Memory Scan .....	63
Priority Scan and Shift Scan .....	64
<b>6. Functions .....</b>	<b>65</b>
Communication Settings (CONFIG) .....	65
Common.....	65
Analog .....	66
FM/NFM .....	66
Digital .....	68
DCR, NXDN .....	68
DMR .....	68
dPMR: .....	69
D-STAR:.....	69
C4FM (DN):.....	69
F-COUNT (Frequency Counter) .....	70
Quick Recall .....	71
Quick Recall Initial Value.....	71
Registering and Recalling Quick Recall .....	71
Quick Recall Registered Contents .....	71

<b>7. Useful Functions .....</b>	<b>73</b>
Key Lock.....	73
Offset Step.....	73
GPS Display .....	74
Display Examples (GPS Display).....	74
Satellite Display.....	76
Position Display .....	77
AIS Reception .....	77
Examples of Display (Position Display).....	78
Receiving Messages .....	79
Message Log.....	80
<b>8. Set Mode .....</b>	<b>81</b>
Set mode list.....	81
How to set Setting Mode .....	83
Display mode.....	83
Antenna .....	84
Message Log.....	84
Scan .....	84
Scan Speed.....	84
Hold Timer.....	84
Release Timer .....	85
Stop Freq(Frequency).....	85
Manual Hold.....	85
Priority Interval .....	85
MHz Scan Width .....	86
Freq(Frequency) Shift Scan .....	86
MN(Memory Name) Search .....	86
VFO Scan.....	86
All Scan Set.....	86
Skip .....	87
Program Link.....	87
Bank.....	87
Bank Link .....	87
Audio .....	87
Beeping Sound.....	87

---

Vol(Volume) Reduction.....	87
Removal Setting.....	88
Vol(Volume) Stabilization .....	88
Bass Supp(Suppression) .....	88
Treble Supp(Suppression) .....	88
Display.....	89
BL(Backlight) Timer.....	89
BL(Backlight) On Bright.....	89
BL(Backlight) Off Bright.....	89
BL(Backlight) USB Charge.....	89
BL(Backlight) Range .....	90
BL(Backlight) Trigger.....	90
BL(Backlight) Hold .....	90
Manual BL(Backlight) .....	90
S-Meter Set.....	90
Message Display.....	91
Display Color.....	91
Position/Distance.....	93
Position System .....	93
Fixed Lon(Longitude) Lat(Latitude).....	93
Memory Dist(Distance).....	93
Position Dist(Distance).....	93
Time zone .....	94
Operations.....	94
MONI Setting.....	94
Selector Acceleration .....	94
Dial.....	94
Ring.....	94
Vol(Volume)/Sql(Squelch) Swap .....	94
Dial Vol(Volume) (Lock).....	95
QR(Quick Recall) (Lock).....	95
Key Lock Range .....	95
FUNC Hold Time.....	95
Power .....	95
Battery Save (BS).....	95

- Auto Power Off..... 96
- USB Pow(Power) Supply ..... 96
- USB Charge..... 96
- Adjustments..... 97
  - S-Meter ..... 97
  - Standard Freq(Frequency)..... 97
- Status ..... 98
  - Power Status..... 98
  - Device Infor(Information)..... 99
- 9. PC Connection..... 100**
- 10. Reset..... 101**
  - Reset(Only display) ..... 101
  - Reset(Partially) ..... 101
  - Reset(All)..... 102
- 11. Option List..... 103**
- 12. Maintenance..... 104**
  - Trouble Shooting Guide..... 104
- 13. Technical Specifications ..... 105**



## ◆◆◆ Functions and Features ◆◆◆

The DJ-X100 is a digital multi-mode receiver which receives radio media from very high frequencies (VHF) to ultra high frequencies (UHF).

The DJ-X100 has the following main features:

- Covers the V/UHF range from 30 to 470 MHz.
- Equipped with a GPS receiver, which can search and scan for the nearby channels using the longitude and latitude data registered in the memory.
- The memory holds 999 channels, 50 pairs of program scans, 26 banks, and name tags up to 28 characters can be displayed in the memory.
- Equipped with an offset step function that applies a 1/2 step shift.
- Analog AM and FM are also processed with DSP to achieve clear reception sound.
- The analog reception tones include CTCSS and DCS, and FM radio mode that allows to listen to FM broadcasting while waiting for communication.
- Equipped with a USB Type-C connector can be used for charging and as an external terminal in addition to connecting to a PC with a standard accessory cable.
- Equipped with a large-diameter speaker and BTL amplifier for clear reception sound, and supports stereo earphones for reception in both ears. (Audio signal is monaural.)
- Alinco's first IP67 dustproof and waterproof receiver, and in addition to the supplied li-ion battery, it can also be used with an optional dry cell battery case (3 AA dry cell batteries) or a commercially available portable battery (charger, power bank, external battery) for prolonged field reception.  
\*It may be more likely for noise to be heard when using a portable battery.
- A design inspired by measurement instruments and the glass cockpits of aircraft, featuring a color TFT display with intentionally adopted monochrome to enhance visibility. Backlight and font colors customizable via RGB values, offering freedom in combinations.
- Keys specialized for frequency input, mode and step switching, with an ergonomic layout designed for ease of use. The keyboard is membrane-type, featuring a flat design that is easy to press.
- A wide range of optional accessories are also available, including a li-ion battery charger (EDC-325T), dry cell battery case (EDH-46), and a soft case (ESC-65).

# 1

## Before use

### Check accessories

The following items are included with DJ-X100T/E. Please check them before use.

- DJ-X100(FCC: T/ CE: E)
- Li-ion battery pack (EBP-114A)
- USB adapter EDC347 (For T) EDC348 (For E)
- USB cable (EDS-39)
- Whip antenna (EA-295)
- Belt Clip (EBC-65) 2 screws included (Installed)
- Instruction manual

#### NOTE:

Accessories may differ depending on the version you have purchased. Please contact your local dealer for details of standard accessories and the warranty-policy before purchase.

### Attach / Detach Accessory

#### ■ Antenna EA-295

1. Hold the antenna by its base.
2. Align the grooves at the base of the antenna with the protrusions on the antenna connector.
3. Slide the antenna down and turn it clockwise until it stops.
4. Confirm that the antenna is securely connected.  
Check the connection from time to time.

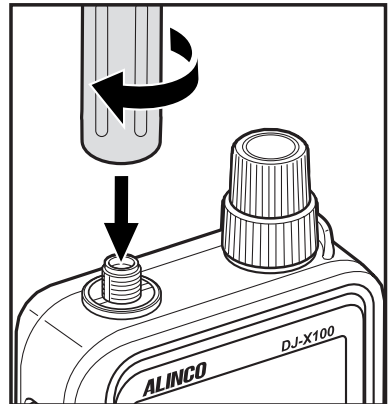

### ■ Belt clip EBC-65 (Belt clip x1, Screws x2pcs)

The belt clip is packaged with the product attached. To remove the belt clip, use a screwdriver to unscrew it counterclockwise.

\*Check for any loosening of screws regularly. The belt clip is a consumable item. Spare parts are available for sale, so please consult your retailer. Using screws other than those provided as standard accessories may damage the receiver unit. Never use screws that do not meet the specifications.

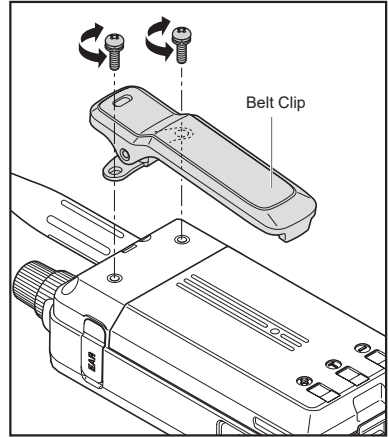

### ■ LI-ion battery pack EBP-114A

#### ● Attach Battery Pack

Align the battery pack with the tabs on the main unit, then push the battery pack firmly in the direction of the arrow to secure it in place.

Due to its waterproof design, the locking lever may feel slightly stiff. Please make sure that the locking lever is securely fixed in the position shown in the diagram. If it is not securely fixed, it may cause poor contact, resulting in power failure or the battery coming loose. Also, please ensure that no foreign matter, such as dust, is attached to the seal. This could reduce the waterproof performance.

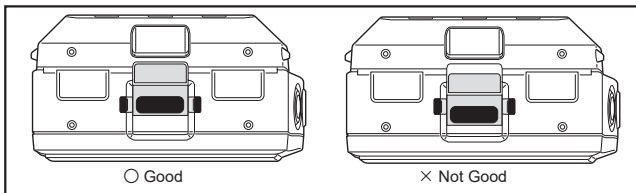
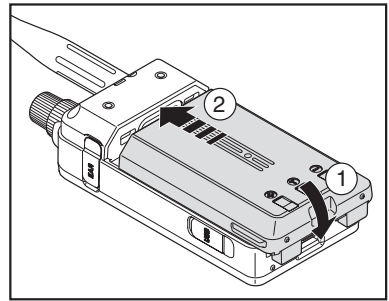

#### NOTE:

Do not touch or affix labels to the two circular indentations located above the nameplate on the back of the main unit. These are important for maintaining waterproofing.

● **Remove Battery Pack**

Slide the lock lever at the bottom of the battery pack in the direction of arrow (1) and remove the battery pack (2).

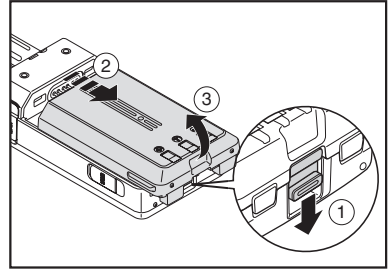

**NOTE:**

Be careful not to damage your fingers or nails when sliding the battery pack.

■ **Optional Dry Cell Battery Case EDH-46**

- The installation method for EDH-46 is the same as for the battery pack. Please refer to the optional accessories list page (P.103) in this manual or the instruction manual included with the EDH-46 for information on how to insert dry batteries and handling precautions. Be sure to read it carefully. EDH-46 is not water / dustproof
- Never use disposable Li-Ion AA battery cell. It has a high initial voltage, which may damage internal electronic components. Be sure to use reliable Alkaline AA drycell batteries. The use of manganese batteries or nickel-metal hydride rechargeable batteries is not covered under warranty."

■ **Estimated operating hours for battery pack and dry cell battery case**

Condition : RX 6sec, 54sec Stand-by with battery save ON.

Battery pack / Dry cell battery case. (Approx)

- GPS/FM broadcasting : Off 16 hours / 7 hours
- GPS : On (FM off) 13 hours / 6 hours
- FM: ON (GPS off) 12 hours / 5 hours

**Important**

- This device prioritizes digital reception, and Battery Save (BS) is set to OFF by default. When receiving digital and data signals, leaving it OFF may hinder reception and decoding.
- It is recommended to turn Battery Save on in Analog mode. If you do not turn on BS using the set mode operation described later, the estimated battery usage time may decrease by about 30%.
- No icon to describe BS status, but enable to check at [Device Information]. When turn off the power and press [MONI] key while turning on the power, the current settings will be displayed. If "BAT SAVE" is displayed here, BS is enabled. Please refer to P.99 for details.

## ■ Prevent Short Circuiting from the Battery Pack

Be extra cautious when carrying the rechargeable battery pack; short circuiting will produce surge current possibly resulting in fire.

Even with 1.5V AA batteries, temperatures can rise to over 90°C in just a few minutes, so it's essential to exercise caution.

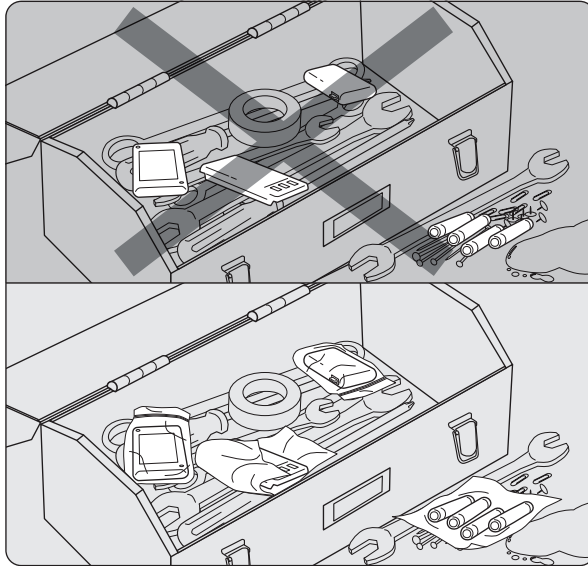

- Do not carry batteries in metal containers or in a bag containing objects such as metal tools, clips, screws, keys and jewelries.
- Do not carry batteries in wet conditions. Water is conductive and may cause short-circuit.
- The batteries must be packed in a dry nylon bag one by one when carried or stored to avoid shortcircuit.
- Take batteries off of the receiver before storing them for extended period of time. Store them in a dry, cool and dark place. Supplementary chargers is required from time to time and details are explained later in this manual.

## ■ Battery Information

**Failure to observe the following precautions may result in ignition.**

- Do not under any circumstances leave the battery pack in places where it may become hot, such as inside a car or near heaters, regardless of the season or temperature.
- If the charging does not complete even after the specified charging time has elapsed, please immediately stop the charging process.
- The battery pack is a consumable item. The estimated number of charge cycles is between 300 and 500 cycles. Please regularly check the charging status. If you notice any abnormalities such as increased heat or swelling, immediately replace the battery pack.
- Do not use deteriorated battery packs. To fully utilize the receiver's performance, it is recommended to replace the battery pack within approximately 3 years, and no later than 5 years.

- When the battery pack experiences a strong impact, such as being dropped on a hard floor or hitting a wall, please replace it with a new one. If small scratches occur inside the battery, they can become the cause of smoking or fire.

**NOTE:**

- Never modificate, disassembly, exposure to fire, immersion into water. or use incorrect battery pack. It may cased of overheating, rupturing, so that it is extremely dangerous.
- The battery pack is not fully charged when shipped. Please fully charge it after purchase before using it.
- Charging should be cnducted in a temperatre range of 10°C to +40°C (+50°F to +104°F).
- Never short-circuit the terminal of battery pack. It may cause of damage to the radio, burned by battery overheating.
- Do not overcharge so that it may reduce the battery's performance.
- When storing the battery pack, choose a location with low humidity and dry conditions within a temperature range of -10°C to +45°C. Avoid storing it in temperatures outside this range or in extremely humid environments, as it may cause leakage of the battery's liquid or corrosion of metal parts.
- Storing battery pack with unused for a long time leads to unable to charge due to over-discharge.  
Occasionally charging and using the device for short periods is the best storage method.
- This device consumes standby current. Even when the power is turned off with the battery pack installed, it still consumes a small amount of current. It will discharge in a few days, so when not in use for even short periods, please remove the battery pack.

## ■ How to recharge Li-ion battery pack

The device can full-charge the included Li-ion battery pack through the main unit using the provided USB adapter. It takes about 5 hours to charge from a discharged condition.

**NOTE:**

- When you purchase the battery pack or if it has not been used for a long time, please fully charge it before use.
- When using charging optional stand and AC adapter, please use the genuine ALINCO products. Connecting unspecified products may cause accidents or fires.

## ● USB adapter

1. See P.19 to install the battery pack.
2. Open the receiver's USB port cap.
3. Connect the Type-C end of the USB cable to the receiver.
4. Connect the Type-A end of the USB cable to the supplied USB adapter.
5. Plug the USB adapter into an electrical outlet.

Refer to "Battery Icon Display" (P.25) for details.

\* It may heat up while charging, but this is not an abnormality.

\* The rubber cap of the USB port must be closed securely each time. If it is not closed properly, it cannot provide outer protection. If left open for long periods of time, the rubber may warp and make it difficult to close. Please be careful of moisture and dirt when unable to close it properly. Leaving it for a while will allow the shape to return to normal and close properly.

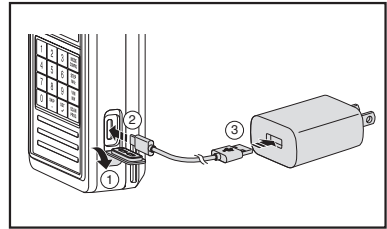

\*Illustrations may differ from the actual product.

### NOTE:

- Depending on the combination of power on/off status of it may take up to 2 seconds before the charging icon appears. If the charging icon does not appear after more than 2 seconds, connect the USB cable after turning on the power. This operation is related to internal processing when the charging circuit is activated and is not an abnormality.
- The supplied USB cable can be connected to a PC or portable battery to charge the battery, but the charging time will be longer due to the lower current, and the battery may not charge fully, but this is not an abnormality.
- Any malfunctioning with commercially available USB adapters or USB cables is not covered by the product warranty.
- When charged while operating in a high-temperature environment, charging may not be possible. For safety reasons, charging will stop when the temperature of the battery pack rises. The charging will resume when the temperature drops. Turn off the power and allow the battery pack to cool down before charging.  
The charging status can be checked under "Power Status" (P.98) within the Power Menu of Set Mode.



### REFERENCE

The supplied USB adapter allows charging while the receiver is in operation.

When fully charged, it is powered by the current from the USB adapter, preventing the battery from depleting.

However, constant use of the USB adapter will accelerate battery degradation, so it is recommended that the battery pack be removed once it is fully charged and then stored.

Reception can be continued via USB without a battery pack. At this time, keep metal products away from the battery terminals on the back of the receiver to avoid causing them to short-circuit.

The USB adapter may generate noise and affect reception, but this is not a product abnormality.

● **Optional accessory: EDC-325**

If use optional accessory EDC-325B, it can finish re-charging battery from empty to full about in 3.5 hours.

1. Connect charger stand (EDC-325T) to AC adapter (EDC-330)
2. Insert AC adapter to outlet, and put radio to charge stand.  
Lit the lamp to red during charging. If used outside the operating temperature range of the charger (+10 to +40°C/+50°F to +104°F)., it will flash red and green.
3. When finished charging, Light the lamp up to green.

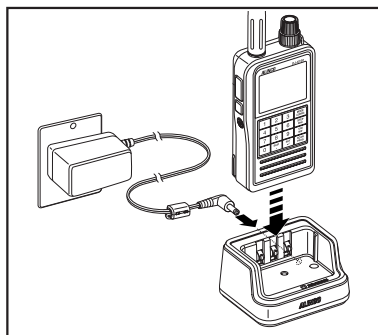

\*The appearance of the AC adapter may vary.

**[Receiving while charging.]**

While placed on the charging stand, you can still receive signals and charge simultaneously. However, since electric current flows through the receiver unit during charging, the detection of full charge may be disrupted, resulting in the green lamp not lighting up.

- \* Using this method is not recommended as it also puts strain on the battery pack.
- \* For safety reasons, this device is equipped with a timer that stops charging after approximately 6 hours.
- \* When the timer activates, charging stops, but depending on the charging status, the green or red lamp on the charging stand will illuminate
- \* The charging will resume when the battery voltage drops, and it will repeat the cycle of charging stopping after 6 hours. Therefore, depending on when you remove the receiver from the charger, it may not be fully charged.
- \* Removing the receiver from the charger and then inserting it again will reset the timer. Be careful not to frequently insert and remove it, as this may accelerate the degradation of the battery pack due to overcharging.
- \* While charging on the charging stand, the battery icon on the receiver will not display the charging status.
- \* The AC adapter may generate noise that could affect reception, but this is not considered a malfunction of the product.
- \* While receiving signals during charging, the temperature of the device may increase. Even within the charging temperature range of below 40°C, in hot environments, the protection circuit may activate, preventing charging. When the temperature decreases, it will automatically return to normal charging.

 **REFERENCE**

If charging the receiver with the battery pack attached is unsuccessful, please check if the battery pack can be charged separately to ensure there are no abnormalities.







## ■ Battery icon

The battery icon displayed on the device's screen indicates the remaining battery level. When the battery icon is empty, please charge the battery pack or replace it with new dry batteries.

### ● Battery level

Indicate battery capacity in 5 stage.

	The battery level is enough.
	The battery level is decreased a little.
	The battery level is decreased. Recommend charging.
	The battery level is almost empty. Recommend changing the battery.
 (Flashing)	The battery level is empty. Recommend changing or charging the battery immediately.

### ● During the charge

During charging, flash empty battery icon and current battery status alternative.

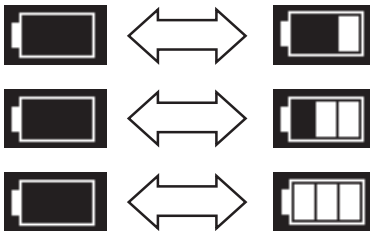

#### NOTE:

The battery level during charging is only an estimate. When charging starts with the USB connected, the battery level icon may be increased, and when the USB is removed during charging, the battery level icon may be decreased, but this is not malfunction.

#### REFERENCE

When the device is off and charging, only the battery icon will be displayed on the display. When the device is fully charged, the battery icon will change to a USB mark, then all displays will disappear.



# 2

## GETTING ACQUAINTED

In this manual, “press, short press” refers to pressing the key firmly for a short time and then immediately releasing your finger. “Long press, press for \* seconds” refers to continuing to press the key until the described state is reached. If press the key incorrectly, it may perform a different action.

### ■ Main unit Top and front

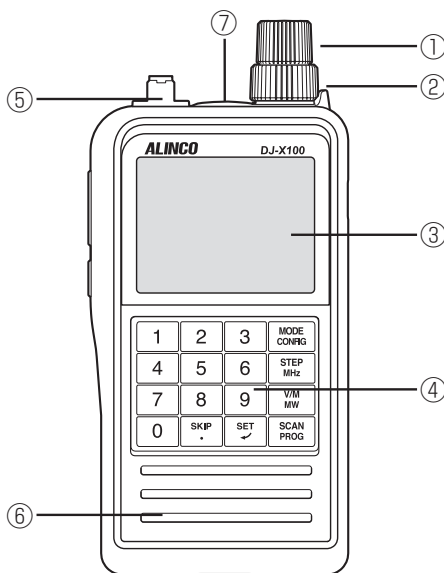

No.	Name	Function
①	Dial	Change the frequency, memory channel, and various settings.
②	Ring	Change the volume. * You can customize the functions of the dial and ring by switching them in the set mode. (P.94)
③	Display	Display the status of this unit. Details are described later.
④	Keyboard	Use for direct frequency input and various settings.
⑤	Antenna Connector (SMA-J)	Attach the included antenna securely. When using an optional antenna, select an antenna that is tuned to the receiving frequency range.
⑥	Speaker	A thin speaker is built in
⑦	GPS Antenna	A small GPS antenna is built in. Make sure the top of the unit faces the sky.

## Side

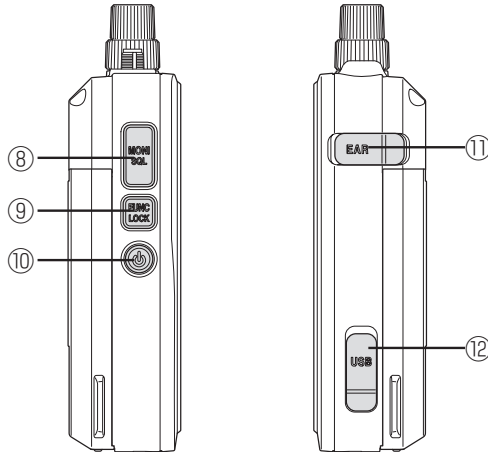

No.	Name	Function
⑧	[MONI] key ([SQL] key)	Press to open the squelch to ease hearing the receiving sound.
⑨	[FUNC] key ([LOCK] key)	Use this key in combination with another key to operate the unit. Press and hold the key to lock.
⑩	[POWER] key	Press for about 1 second to turn the power on and off.
⑪	Earphone terminal	Connect earphones. (ø 3.5 mono or stereo *mini plug) *It sounds in both ears but not in stereo.
⑫	USB port	Used as an external power terminal, as well as for charging and communication with a personal computer. (Type-C, 5V/1.5A)

### ■ Display example

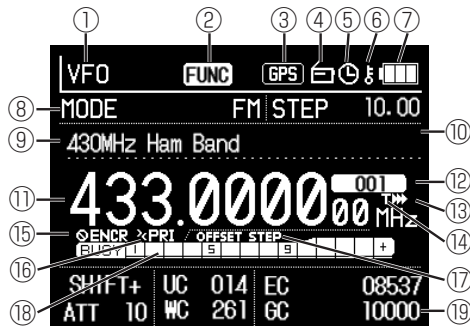

The actual display may differ.  
UC/WC/EC/GC etc are not used in FM mode.

No.	ICON	Function
①		Display the operation mode.
②		Lights up when [FUNC] key is pressed shortly. It will disappear after 5 seconds if no operation by default. (P.95)
③		Appears when using the GPS receiver. (P.93) [GPS] lights up: When the GPS is capturing the location information [GPS] blinks: When the GPS cannot capture the location information [FIX] lights up: When FIX is selected for “location information” and the location information (fixed longitude and latitude) has been registered [FIX] blinks: When FIX is selected for “location information” but the location information (fixed longitude and latitude) has not been registered Off: When GPS or FIX “location information” is not used (OFF)
④		FM radio: Lights up when on and goes off when off.(P.47)
⑤		Auto power off: Lights when on, turns off when off. (P.96)
⑥		Key Lock : Lights when key lock is activated. (P.73)
⑦		Displays the remaining battery level and charging status. For details, see “Battery icon display” (P.25).
⑧		The MODE on the left is the type of signal set to receive. The one on the right is the frequency width or step that changes with one click of the dial.
		If register longitude and latitude in the memory, the distance between two points can be displayed in km when receiving your current channel position information by GPS or FIX.
		While receiving GPS signal or using FIX with position info, if the receiving signal carries position info such as D-STAR voice, the distance and direction between 2 points will be displayed in km, eight directions.
		Display level and bar graph when adjusting volume and squelch.
⑨		Display the name assigned to memory or scan.
⑩		Display when manual backlight function is enabled and constantly “ON”. (P.90)
⑪		Display the receiving frequency.
⑫		Display the memory channel, bank, and scan number.
⑬		Light up when skip is set. (P.46)
⑭		Light up when timer skip is set. (P.46)
⑮		Light up when encrypted signal is detected.
		Light up during data communication.
⑯		Light up during priority scan. (P.45)
⑰		Light up when offset step is used. (P.73)
⑱		Display the receiving level. S meter.

No.	ICON	Function
19	 SHIFT- UC 014 EC 08537 ATT 10 WC 261 GC 10000	Display the settings of the shift and attenuator, etc., and information on the received signal. Display various info regarding Shift direction, attenuator and codes used in Japanese DCR digital voice signals.

## ■ Key operation



1	2	3	MODE CONFIG
4	5	6	STEP MHz
7	8	9	V/M MW
0	SKIP .	SET ↙	SCAN PROG

Key	Short press	Long press (1 second)	Operation after pressing [FUNC] key
1	Press 1	In default setting, shortcuts to main bands. After setting, quick recall	Long press and register quick recall for each key.
2	Press 2		
3	Press 3		
4	Press 4		
5	Press 5		
6	Press 6		
7	Press 7		
8	Press 8		
9	Press 9		
0	Press 0	Quick Recall List	—
SKIP .	SKIP ON/OFF	Timer skip ON/OFF	Skip channel edit
SET ↙	Enter set mode and confirm operation	Set current memory CH info to VFO.	Frequency counter ON/OFF
SCAN PROG	SCAN ON/OFF	Select Scan mode setting	Enter Scan List
V/M MW	Switch between VFO and Memory mode	Enter memory mode setting	Registers memory ch in VFO (Memory Write), enters Memory editing menu in memory mode.
STEP MHz	Enter Frequency step setting.	ON/OFF the offset step in VFO mode	Changes VFO frequency in 1MHz step.
MODE CONFIG	Enter Receiving mode	FM Radio ON/OFF	Enter Config setting.
MONI SQL	MONI ON/OFF		Use dial to set squelch level.

Key	Short press	Long press (1 second)	Operation after pressing [FUNC] key
FUNC LOCK	FUNC ON/OFF FUNC icon appears to show it is in FUNCTION status.	Key Lock	Manual backlight on/off (Only when setting is enabled)
 (POWER)	—	Power ON/OFF	—
Dial	Increase/Decrease frequency (Can also be assigned to another function)	—	10x frequency step (VFO mode) 10 channel increase/decrease (Memory mode)
Ring	Increase/Decrease volume (Can also be assigned to another function)	—	(Can be assigned to functions in set mode)

• When on selection screen

Keys are used as shortcuts while operating in SETTING mode by pressing SET key.

Key	Short press
1	Exit from settings
2	Move cursor upward
3	Move to previous page
4	Move cursor leftward
5	Confirm selection
6	Move cursor rightward
7	Cancel or go back
8	Move cursor downward
9	Go to next page
SET ↵	Confirm
MONI SQL	Cancel or go back
FUNC LOCK	Turns on/off FUNC operation
Dial	Move cursor

Exit	↑	Page Up	MODE CONFIG
←	Enter	→	STEP MHz
Cancel	↓	Page Down	V/M MW
0	SKIP .	SET ↶	SCAN PROG

\* Above illustration shows the key action in SETTING mode. This is for explanation purposes and such keyboard does not exist.

# 3

## BASIC OPERATIONS

### ■ Turning the Power On and Off

Hold down [POWER] key about 1 second to turn on the power.

Perform the same operation to turn the power off.

The ALINCO Logo, Model Name, Firmware Number, and “Battery Voltage” or “USB” will be displayed before booting. Release your finger when this is displayed. The reception screen will then be displayed.

The illustration on the right is of the initial display in the default state or immediately after a reset.



To turn off the power, remove your finger when “Turn Power Off” is displayed. When held down, the power may not turn off.

### ■ Adjusting the Frequency

#### ● Setting the Frequency with the Dial.

Turning the Dial changes the frequency according to the step width described below. In Memory Mode, channels can be changed if there are registered memory channels.

The frequency and memory channel numbers are higher (larger) when the Dial is turned clockwise and lower (smaller) when turned counterclockwise.

Press [FUNC] key, and while <FUNC> icon is displayed, turning the Dial in VFO Mode will change the frequency greatly by steps of 10-fold increments. In Memory Mode, 10 channels can be changed with one click. Press [FUNC] key or leave it be for 5 seconds to return to the previous setting.

When [FUNC] key is held down for too long, the key lock is activated and the operation is disabled. Hold down one more time to cancel.

#### ● Entering Frequencies Directly

Frequencies can be entered directly by operating the numeric keys.

1. First enter the MHz digits, and then press [SKIP (.)] key.
  2. Continue to enter the kHz units.
  3. Press [SET] key or enter 6 digits for the kHz to confirm. There will be a beeping sound, and <MHz> will be displayed at the end of the number.
- \* When the entered frequency is between 76 and 108 MHz, it will shift to radio mode.
  - Details of the Radio Mode are explained within the “FM Radio Mode (P.47)”.
  - \* If a frequency that cannot be received is entered by mistake and [SET] key is pressed, there will be a “buh-buh” error sound. If you notice an error while entering, press [MONI] key to start over.

Example 1: Entering 123.000 MHz

Press [1][2][3] keys, and then press [SET] key

Example 2: Entering 123.45 MHz

Press [1][2][3] [SKIP(.)] [4][5] keys, and then press [SET] key

Example 3: Entering 123.456789 MHz

Press [1][2][3] [SKIP (.)] [4][5][6][7][8][9] keys, and then press [SET] key

 REFERENCE

There is no function to round the entered values in the set step. Therefore, frequencies such as in Example 3 can be entered, but when [Dial] is turned, it will switch to the set step. It is not necessary to change the step value to a rounded value before changing it.

■ Adjusting the Volume

The range of volume adjustment is 33 levels from 0 to 32.

The default is set to 0.

When the ring is turned while in the default state, it will make a “buzzing” sound.

When the level is set low and the squelch level described below is adjusted, the “buzzing” sound will disappear. After this, it will make the “buzzing” sound while [MONI] key is pressed.

The volume can be adjusted using this sound as a reference.

The volume increases moving clockwise and decreases moving counterclockwise.

Both the volume and the squelch settings described below are retained until next time they are changed, even if the power is turned off.



 NOTE:

When using earphones, lower the level beforehand and then gradually increase it for your safety.

■ FUNC (Function) Key Operations

After pressing [FUNC] key briefly, the <FUNC> icon will disappear and the display will return to its original state if no operation is performed for 5 seconds. This is to enable automatic recovery even for when the FUNC status is unintentionally set through misoperation. This setting has the options of 5, 10, 20, or 30 seconds for holding the FUNC status until the next operation. Since this key is often used, not only for the squelch, it is recommended that this be changed to one’s preferences in advance.

“Hold” is especially useful while still getting accustomed to the operations.



How to Set Up:

1. Press [SET] key in standby mode
2. SETTING and the menu will be displayed. Turn [Dial] to select [Operations].
3. Press [SET] key again and turn [Dial] to select "FUNC Hold Time."
4. Press [SET] key again, turn [Dial] to select the desired value, and then press [SET] key to confirm.
5. Press [MONI] key twice to return to the reception screen.

This explanation may be omitted hereafter; <FUNC> icon is displayed to the left of the <GPS> icon on the display when the key is pressed and in the FUNC status.

## ■ Squelch level and S-meter

### ● About squelch

Squelch eliminates buzzing noise heard at standby state. When receiving signals and sounds heard from the speaker is referred to as "opening the squelch" and the reverse of this is "closing the squelch." The level should be adjusted according to noise floor level of your location.

Audio volume should be set to proper level in analog mode in advance. Squelch level is adjustable between 0 and 32. The default is 0 and squelch remains open. After pressing [FUNC] key, press [MONI] key. Turn [Dial] when <SQL> and level number are displayed, higher moving clockwise and lower moving counterclockwise.

We recommend to set SQL level disregarding level number like the analog receiver without display in the past when adjustments were made only by one's sense of hearing. In addition, the level should be higher so that <BUSY> icon disappears while receiving digital signals for proper scanning.

### ● About S-meter

Unlike common receivers, it is normal for DJ-X100 to indicate signal (noise) levels even when squelch is applied. Receiver users often request to see noise levels in communication receivers, similar to the S-meter on shortwave radios. If you set the squelch level correctly, you won't hear noise and can perform scanning regardless of S-meter indication.



IN CASE A CONVENTIONAL S-METER FUNCTION IS PREFERRED, follow the instruction below:

Press [SET]key > Select [Display] and press [SET]>Select [S-meter set] > Press[SET]>Select [Busy Linked]>Press [SET]>Press MONI key until returning to Standby state.

● About [BUSY] icons

There are two types of [BUSY] icons that light up when the squelch is open or when a signal is received: whitewashing and outlined.

In analog modes, when a signal is received, the whitewashing [BUSY] will light up. When squelch opens, but because CTCSS/DCS tone etc. may be different and no audio is output, an outlined [BUSY] is displayed.

In digital modes, when a decodable signal is received, the whitewashing [BUSY] will light up. When squelch opens, but because digital format may be different and not decodable, an outlined [BUSY] is displayed. This means that whitewashing [BUSY] is a sign of possibly decodable signal for DJ-X100, even though due to signal strength, digital format and code setting etc, the audio may not be heard or corrupted.

■ Monitoring Function

This function temporarily ables to open the squelch when the received signal is weak or the sound is interrupted, and it also turns off the tone squelch and DCS in analog mode to facilitate reception.

By default, the squelch opens only while [MONI] key is pressed and returns to the set squelch level when released. Pressing [MONI] key within the MONI Setting (P.94) of the Set Mode described below will open the squelch, and pressing it again will close it. In both cases, <BUSY> will blink on the display while monitoring.

REFERENCE

The MONI function can also be handy to check for incorrect settings in CTCSS, DCS etc.

■ Selecting Receive Mode

Press [MODE] key to select modulation mode. Detailed settings are performed according to the type of radio wave, the digital communication standards, and other factors from the three categories of analog, digital, and data.

1. Press [MODE] key to display the Receive Mode screen.
2. Turn [Dial] to select the mode, and then press [SET] or [MODE] key.
3. Turn [Dial] to select from the Receive Modes displayed, and then press [SET] or [MODE] key to confirm the selection and return to the reception screen.

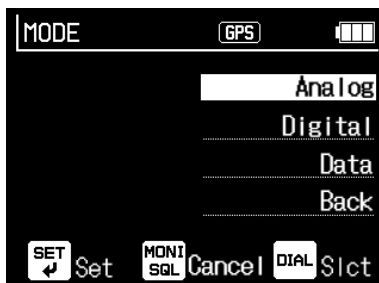

NOTE:

When receiving analog voice communications, turning on “Battery Save” (P.95) within the “Power” settings of Set Mode will extend battery life. BS setting is not recommended for digital/ data reception as they often disturbs signal decoding.

### ● Analog

FM, NFM, AM, and NAM

- FM : Classic 20kHz-step FM communications like in VHF marine radio
- NFM: Narrow FM at the UHF band. Popular 12.5 kHz-step FM communications
- AM : Typical for Aeronautical Radio
- NAM: Narrow AM with a bandwidth slightly narrowed by filters  
This is used to avoid interference from neighboring stations. However, it may help to hear better when the signal is weak due to it sounding as if the high frequencies are cut off slightly. Use it as desired.

### ● Digital

DCR, NXDN, DMR, D-STAR, dPMR and C4FM(DN)

### ● Data

AIS: Automatic Identification System for navigation.

ACARS: Aircraft Communications Addressing and Reporting System

12kIF(W): Output of received signal at 12 kHz IF (bandwidth 15 kHz)

12kIF(N): Output of received signal at 12 kHz IF (bandwidth 6 kHz)

\* These 12 kHz IF (intermediate frequency) outputs are adopted as it is sometimes used in third-party receiver software. It is not used for normal reception or with Alinco's reception software.

\* The data communication decoding of the receiver is also compatible with other systems and not limited to above. Appropriate software may be necessary though.



### REFERENCE

When the selection or setting screen is displayed, an icon explaining the operation appears at the bottom of the screen.

The key shown on the selection screen also serves as the confirm key. For example, when proceeding to the selection screen using [MODE] key, [MODE] key replaces [SET] key. This explanation is at times omitted as it appears repeatedly.

## ■ Receiving Communications

- Communications are not broadcasting. Most calling is performed when necessary and with minimal facilities, and there are exceedingly few communications with frequent radio waves.
- Noises heard when signals are not being received (those referred to as back noise, white noise, etc.) vary in loudness and quality depending on the type of radio wave, air conditions, frequency, and other factors.
- The strength and sound quality of the radio waves received are affected by various factors, such as the power source used (AC adapter, batteries, etc.), the location and conditions (the presence of fluorescent lights, TVs or other electrical equipment, wooden or rebar construction, the area of one's residence, whether one is standing or walking, etc.), and the air conditions.
- The supplied whip antenna is designed primarily for outdoor reception. For efficient reception inside buildings, etc., install a commercially available external antenna that is compatible with receiving frequencies.
- In areas with strong electric fields, such as near mountains where radio towers and transmitting stations are concentrated, radio broadcasts, for example, may be heard overlaid on airplane transmissions, but this is not a defect. The attenuator function described later can be used to reduce these interferences and disruptions.

# 4

## OPERATION MODE

The DJ-X100 has five operation modes: VFO Mode, VFO Scan Mode, Memory Mode, Memory Scan Mode, and FM Radio Mode.

VFO Mode	This selects the frequency by turning the dial or using the numeric keys. The frequency of the set frequency step moves one step with one click of the Dial. VFO is a radio term deriving from Variable Frequency Oscillator.
VFO Scan Mode	This mode automatically searches for signals within a VFO Mode band. There are six types of scans to select from: All, MHz, Program, Link Scan, Priority Scan, and Shift Scan.
Memory Mode	This mode recalls and receives pre-registered memory channels. Memory Mode and the Memory Scan seen below will not run until the memory channel has been registered.
Memory Scan Mode	This mode automatically searches for signals being communicated on the registered memory channels. There are six types of scans to select from: All Memory, Bank, Bank Link, GPS Memory Scan, Priority Scan, and Shift Scan.
FM Radio Mode	DJ-X100 becomes a simple, conventional FM radio when [MODE] key is pressed for 2 seconds. Squelch opens, audio level lowers, and functions like scan are deactivated. FM stations can't be registered in memory ch. Observe a radio icon on upper right of the display when it seems malfunctioning or hear a hiss noise even the squelch is set properly. Press MODE,STEP,V/M or SCAN key switches to receiver mode, retaining FM radio reception. Pressing and holding [MODE]key cancels FM radio mode and radio icon will disappear.

### ■ The Receiver's Automatic signaling Analysis Function

This receiver automatically analyzes the CTCSS/DCS tones,D-STAR CS,C4FM DG-ID,and DCR/NXDN User Codes without special settings, and displays the values at the bottom of the reception screen; in addition, the CS, DG-ID, and user code can also be received practically in real time. This runs in both VFO Mode and Memory Mode.

DCR/NXDN sequence codes (E-version only) are also automatically analyzed and decoded when set to AUTO by performing the operations as described below.



#### REFERENCE

- CS, DG-ID, and UC are automatically analyzed when the set initial value is OFF.
- During digital decoding, the first part of the received audio may be corrupted and difficult to hear, but this is not a malfunction.
- The signal must be strong enough to enable normal reception for proper decoding to be possible.
- The identified values and numbers can be written down and used for selective reception by registering them on memory channels as described below.

## ■ Switch the Operation Mode

The figure below shows how to briefly press [MODE], [V/M], and [SCAN] keys to switch between the various modes. In FM Radio Mode, briefly press [MODE], [V/M], [SCAN], and [STEP] keys to toggle between modes while receiving FM radio.

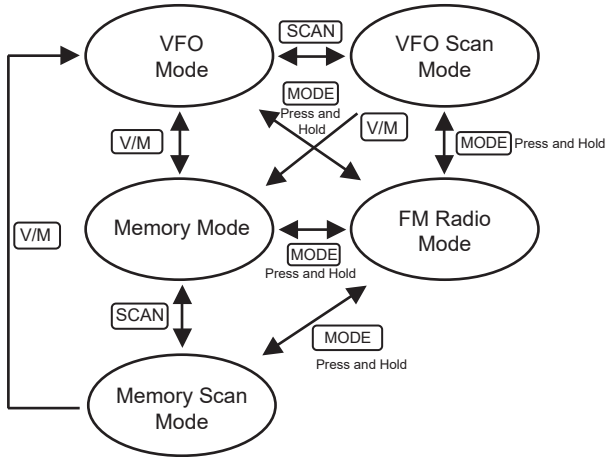

## ■ VFO Mode

As explained in the Basic Operations section, use the Dial and numeric keys to set the desired frequency.

### ● Select the Frequency Step

A frequency step (hereinafter “step”) is the interval between channels assigned to communications. This selects the suitable step, as they vary depending on communication and broadcast allotment rules. In VFO Mode, both the Dial operations and VFO Scans switch frequencies at this interval.

#### NOTE:

The receiver does not have the “AUTO Step” function often employed in wideband receivers. DJ-X100 does not have the “AUTO Step/Mode” functions often employed in communications receivers.

This product is designed for commercial use. Frequency allocations and band plans vary depending on local radio laws and administrations. Alinco doesn't provide informations regarding frequency allocations and band plans.

The selectable steps are as follows (k=kHz):

1k/3.125k/5k/6.25k/8.33k/10k/12.5k/15k/20k/25k/30k/50k/100k/125k/200k

1. Press [STEP] key on the reception screen.
2. When the list of frequency steps is displayed, turn [Dial] to select a value.
3. Press [SET] or [STEP] key to confirm and return to the reception screen.

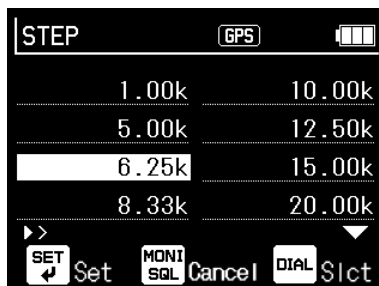

**NOTE:**

When the selection or setting screen is displayed, an operation instructions icon will be displayed at the bottom of the screen like Set/Cancel and Slct(select).

● **1MHz Up/Down**

When you wish to make a large change in frequency while dialing, the frequency can be increased or decreased in 1-MHz increments.

1. Press [FUNC] key until <FUNC> lights up on the display, and then press [STEP] key.

**NOTE:**

The key lock is activated when only [FUNC] key is pressed too long. Press and hold again to cancel.

2. Turn [Dial] to adjust the blinking MHz numbers. The number grows higher moving clockwise and lower moving counterclockwise.
3. Press [MONI] key to confirm, and the blinking will stop.



**REFERENCE**

Depending on the frequency step, it may not increase or decrease in 1-MHz increments. When passing through FM radio frequencies 76 to 108 MHz or other frequencies that cannot be received, the kHz level will be rounded to 00000.

● **10-Fold Frequency Steps**

This is another way to change the frequency greatly by operating the dial. The frequency can be increased or decreased by 10 times the set step value.

For example, when the step value is 10 kHz, it will increase or decrease in 100-kHz increments.

1. Press [FUNC] key until <FUNC> lights up on the display, and then turn [Dial].  
The frequency grows higher moving clockwise and lower moving counterclockwise.
2. Press [FUNC] key again to confirm. When the Hold Time (P.95) of [FUNC] key is not set to Hold, it will automatically be confirmed and return to standby after the set number of seconds has elapsed.

## ■ VFO Scan Mode

This method automatically switches frequencies in VFO Mode for reception. [MODE], [STEP], [V/M], [SCAN], and [SET] keys can be used while scanning.

### REFERENCE

Read this section first, as although Memory Scans are described below in the “Memory Mode” section, there are many operations in common.

### ● Type of Scan

All Scan	This scans all frequencies within the reception range of the Receive Mode (type of radio wave) and step set for the VFO. (except for FM radio broadcast bands)
MHz Scan	This scans a pre-designated range upward from the current frequency with the Receive Mode and step pre-designated for VFO Mode.
Program Scan	This scans a frequency range with the Receive Mode and step pre-designated for the Program Scan.
LinkScan	Program Scan channels are pre-linked to receive several different scan ranges in succession.
Priority Scan	This alternately scans a specific pre-designated channel (priority channel) and the current frequency. This runs even while scanning.
Shift Scan	This runs in both VFO Mode and Memory Mode. This alternately scans the current frequency and the frequency set to be shifted into (e.g., the uplink and downlink frequencies of the relay station).

## ■ VFO Scan

Press [SCAN] key in the default state to start All Scan in VFO Mode. Press [SCAN] key to stop it. Press again to start scanning with the same scan type as was done last time; the scan type selection screen can be displayed by using the VFO Scan Setting in Set Mode (P.86) as described below.

1. Press and hold down [SCAN] key to display the scan type selection screen.
2. Turn [Dial] to select the scan you wish to use, and then press [SET] or [SCAN] key to confirm. Some types of scanning require multiple [SET] or [SCAN] key operations.

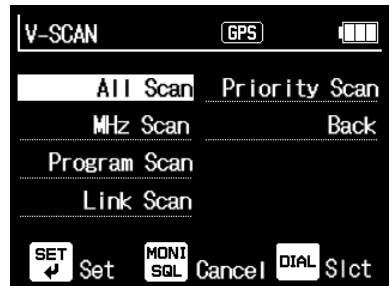

### ● Common Scan Operations

- Turn [Dial] clockwise while scanning to change the scan direction to ascending order and counterclockwise to change it to descending order.
- Press [MONI] key and monitor while scanning to pause the scan, and release [MONI] key to resume it.
- It will resume in the direction of the last scan. If the battery runs out or the power switch is turned on and off, the scan will automatically resume after rebooting. For program scans, the scan starts from the Start Frequency and moves toward the End Frequency.
- Any of the conditions for resuming a scan can be selected in the scan settings of Set Mode. A scan can also be resumed at any time by operating the Dial. See Scan Manual Hold in Set Mode (P.85).
- Enter a 2-digit Program Scan number while scanning to shift to a program scan if there are registered Program Scans as described below. If nothing is registered, there will be beeping sound and the current scan will continue.

### ● All Scan

1. Press and hold [SCAN] key, and then turn [Dial] to select “All Scan” on the scan type selection screen.
2. Press [SET] or [SCAN] key to start scanning. While scanning, the dot and MHz in the frequency display will blink, and “ALL” will be displayed above the MHz.
3. Press [SCAN] key while scanning to stop it. The display will stop blinking.

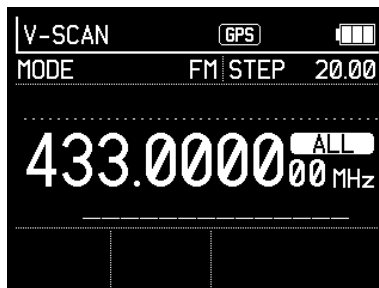

### ● MHz Scan

This repeatedly scans a designated MHz width from the current frequency upward with the Receive Mode and step set in VFO Mode. The following seven ranges can be selected in Set Mode. A specific range can be received more easily than a Program Scan with designated upper and lower limit frequencies.

0.25MHz/0.5MHz/1.0MHz/1.5MHz/2.0MHz/3.0MHz/5.0MHz

The default is set to 1 MHz.

For example, if it is 145.000 MHz, it scans between 145.000 and 146.000 MHz.

1. First read How to Set Up Set Mode (P.83) and then select the “MHz Scan Width” (P.86) in the scan menu.
2. Press and hold [SCAN] key, and then turn [Dial] to select “MHz Scan” on the scan type selection screen.
3. Press [SET] or [SCAN] key to start scanning. While scanning, the dot and MHz of the frequency display will blink, and the “MHz” icon will be displayed above the MHz.
4. Press [SCAN] key while scanning to stop it. The display will stop blinking.

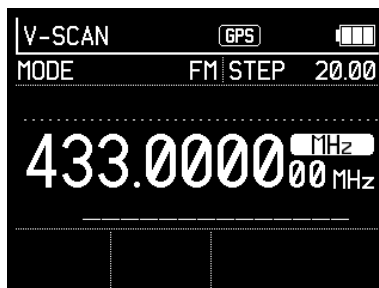



## REFERENCE

- Operations when the band edge or a range without reception is designated
- Example 1: If 2 MHz is designated at 469.000 MHz, it will return to 470.000 MHz and scan between 469 and 470 MHz
- Example 2: If 5 MHz is designated at 74.000 MHz, it will scan between 74 and 76, skipping FM radio band

### ● Program Scan

This sets the upper and lower limits of the scan range and scans within that range. The set frequency pair is called a program channel. The receiver can register 50 pairs of program channels. This must be registered in advance to operate. This scan mode often referred to as "Search".

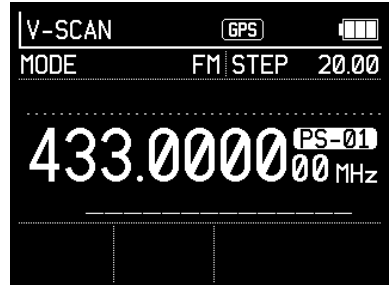

### ■ Registering Program Channels

1. Press [FUNC] key to light up <FUNC> on the display.
2. Press [SCAN] key to display "PROG," and the program channel selection screen will be displayed.
3. Turn [Dial] to select the channel you wish to set, and then press [SET] or [SCAN] key. When "New" is displayed, press [SET] key again. The screen changes to the setting screen as shown below.

#### ● Start Frequency

Press [SET] key for "Start Freq." A scan's Start Frequency can be entered. The default is set to 30.000000 (MHz). As with entering the VFO frequency, use the numeric keys or [Dial] to set the frequency, and then press [SET] key to confirm.

#### ● End Frequency

Turn [Dial] clockwise to select the End Freq. The default is set to 470.000000 (MHz). As with the Start Frequency, press [SET] key to enter the End Frequency on the setting screen, and then press [SET] key to confirm.

In the same way, operate [Dial] and [SET] keys several times to select the mode and step, respectively. The initial value is FM/20.00k.

Air Band, International VHF Marine Radio, Ham Radio, etc. can be received only through the settings up to this point.

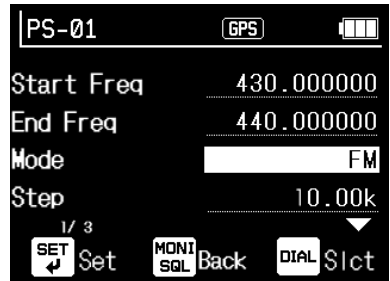

**Important**

When [MONI] key is pressed too many times while in operation, it will return to the program channel selection screen (PROG screen); as a result, all operations performed will be lost and will have to be redone. For efficiency, it is recommended to turn [Dial], select "Write" in the last menu by pressing [SET] key, turn [dial] on the "Do you wish to write?" screen to select "Yes," and then press [SET] key to confirm and save the settings. Selecting a program channel that is being edited on the PROG screen allows for continued operation.

As there will be a great amount of information edited, select "Yes" for "Write," press [SET] key after setting each item, and make frequent use of the write function while operating until you are more accustomed with the operations. Note that edits will not be saved until confirming "Write" with "Yes." At any case programming will be much easier using a free edit tool software.



**REFERENCE**

The DJ-X100 editing software (utility software) makes these settings easy to perform on the computer.

[Communication Settings]

The "Communication Settings" are the CTCSS and other selective call, their tone values, frequency shifts, and the attenuation values of the attenuator. Operate [Dial], [SET] key, and [MONI] key to set them if necessary. For such categories as Air band and International VHF Marine Radio, there are no required operations with the default values.

Available values and initial values are explained in detail in "Communication Settings for Various Functions" (P.65).



[Offset Step]

Operate [Dial], [SET] key, and [MONI] key to turn on and use "Offset Step"

Default value: OFF

For details on offset steps, see P.73.

[Scan Name]

When a scan name is selected, a screen to enter text will be displayed.

The message length is 28 characters.

Default value: Blank

For details on how to enter characters, read the "Memory Name Functions" on P.59

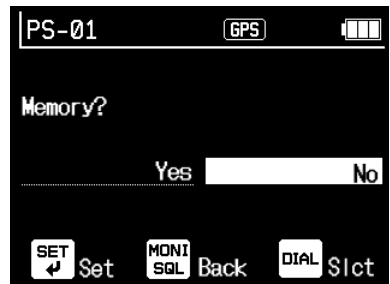

4. Select “Yes” for “Write” to save the edits and return to the PROG screen.

5. Press [SET] key and select “Yes” for “Delete” on the delete screen, and then confirm with [SET] key to delete and initialize the data for that channel.



#### REFERENCE

Data can be partially edited, and the changes can be saved. It is not always necessary to delete and then rewrite.

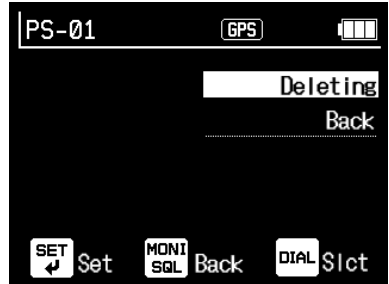

#### ● Link Scan

Linked program channels can be scanned in sequence. This operation cannot be performed unless multiple program channels have been pre-edited.

[Registering and Operating Link Scans]

1. Press and hold [SCAN] key on the receive screen to display the scan type selection screen.
2. Turn [Dial] to select [Link Scan], and then press [SET] or [SCAN] key.
3. When the Link Scan number screen is displayed, turn [Dial] to select the number you wish to edit. Strikethrough lines indicate unedited link scans.
4. Press [SET] or [SCAN] key, turn [Dial], and then select “Add Link” for the items that are displayed.
5. Program channels are displayed. Program channels are scanned in numeric order, not in the order they are linked. Select the program channel you wish to link using [Dial], and then press [SET] key. Each time [SET] key is pressed, the registered program channel will be removed from the list.
6. When the editing is completed, press “Back” to return to the link edit screen. When all program channels are selected, it will automatically return to the link edit screen.
7. Select “Start Link Scan” on the link edit screen, and then press [SET] key to start scanning; the “LS- (Link Scan number)” icon will be displayed above the MHz display. Press [SCAN] key again to stop it.

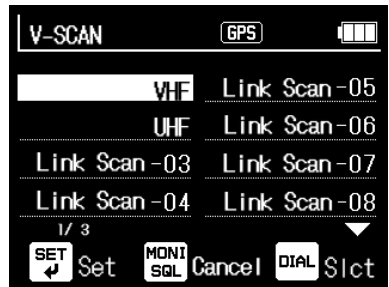

To use a different scan, press and hold [SCAN] key, and then change it on the scan type selection screen.

Select “Link Scan” on the scan type selection screen to scan with a different Link Scan number, press [SET] or [SCAN] key to select the number with [Dial], and then press [SET] key to confirm.

[Deleting Link Scans]

Delete some of the linked Program Scans.

1. Move to the scan type selection screen using the same operations as described in “Registering Linked Scans” above, turn [Dial] to select [Link Scan], and then press [SET] or [SCAN] key. The Link Scan number will be displayed.
2. Select the number you wish to delete with [Dial], and then press [SET] or [SCAN] key.
3. Turn [Dial] to select “Delete Link,” and then press [SET] or [SCAN] key.  
Select the program channel number you wish to delete with [Dial], and then press [SET] or [SCAN] key. It will no longer be displayed after being deleted.
4. When the editing is completed, press “Back” to return to the link edit screen. When all links are deleted, it will automatically return to the link edit screen. Link Scan numbers for which all program channels have been deleted are displayed with strikethrough lines.

[Editing Link Scan Names]

Any name can be registered for registered Link Scans.

1. Move to the scan type selection screen using the same operations as described in “Registering Linked Scans” above, turn [Dial] to select [Link Scan], and then press [SET] or [SCAN] key. The Link Scan number will be displayed.
2. Select the number you wish to edit with [Dial], and then press [SET] or [SCAN] key.
3. Turn [Dial] to select “Link Scan Name,” and then press [SET] or [SCAN] key.
4. Edit the Link Scan name. For details on how to enter characters, read the “Memory Name Functions” entry example on P.59.
5. When the editing is complete, press [SET] key to confirm the edits and return to the previous screen.  
Press [MONI] key to cancel the edit and return to the previous screen.

[Initializing Links]

Initialize and delete registered Link Scans individually.

1. Move to the scan type selection screen using the same operations as described in “Registering Linked Scans” above, turn [Dial] to select [Link Scan], and then press [SET] or [SCAN] key. The Link Scan number will be displayed.
2. Select the number you wish to initialize with [Dial], and then press [SET] or [SCAN] key.
3. Turn [Dial] to select “Initialize,” and then press [SET] or [SCAN] key.
4. When “Do you wish to initialize? Yes / No” is displayed, select “Yes” with [Dial], and then press [SET] or [SCAN] key to return to the previous screen. Press [No] and then one of [SET], [SCAN], or [MONI] keys to cancel and return to the previous screen.

### ● Priority Scan

While receiving or scanning, the receiver can receive a pre-registered priority channel for 0.5 seconds every 5 seconds to check for the presence of a signal. This runs in VFO Mode, Memory Mode, or while scanning.

This item will not be displayed on the scan type selection screen unless the priority channel for memory channel 000 is edited and pre-registered. The same information can be registered in priority channels as in memory channels but a priority channel cannot be used as a memory channel. See Memory Mode (P.49) as described below to register memory channel 000 before operating.

Register the information of the channel you wish to receive priority reception for to memory channel 000.

1. Press and hold down [SCAN] key to display the scan type selection screen.
2. Turn [Dial] to select "Priority Scan," and then press [SET] or [SCAN] key.
3. Turn [Dial] to select "ON," and then press [SET] or [SCAN] key to return to the previous screen.
4. Select [MONI] key or "Back," and then press [SET] key to return to the reception screen in Priority Scan status.

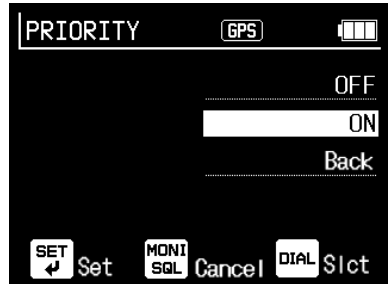

- During a Priority Scan, "PRI" will be displayed below the frequency display.
- In Memory Mode, the memory number icon and the PRI icon on the MHz display are displayed in line with the reception status.

5. To stop a priority channel, select "OFF" in step 3.



### REFERENCE

The priority reception interval can be changed in the Set Mode settings. (P.85)

### ● Shift Scan

This is used when you wish to alternately monitor the destination and source frequencies set to be shifted, such as the uplink and downlink of a relay station. When the frequency shift is not set, it will not be displayed on the scan type selection screen and will not run. For frequency shift settings, see "Communication Settings for Various Functions" (P.65). This runs on both VFO channels and memory channels.

1. Press and hold down [SCAN] key to display the scan type selection screen.
2. Turn [Dial] to select "Shift Scan."
3. Press [SET] or [SCAN] key to start scanning. While scanning, "SHIFT+" or "SHIFT-" in the lower left will blink.
4. Press [SCAN] key while scanning to stop the scan and return to the previous reception screen.



 REFERENCE

The DJ-X100 editing software (utility software) makes these settings easy to perform on the computer.

## ■ Skip

Use this function when you do not wish to stop a frequency for the next scan that had stopped during a scan.

- There are two types of skips: normal skips and time skips.
- Up to 100 VFO Scan skips can be designated for the normal skips and time skips collectively.
- Memory channel skip designations are saved in the memory data. This does not include the 100 VFO Scans.
- Skip designations can be made even when not scanning.
- Skip designations can be separated by bank or link, and they can also be shared. See “Skips” (P.87) in Set Mode for how to do this.

### [Normal Skip]

When a scan stops, press [SKIP] key to register it. When registered, the  icon will be displayed.

Normal skip designations are saved even when the power is turned off.

After pressing [FUNC] key, press [SKIP] key to cancel a skip designation on the skip clear screen.

See “Canceling Skip” described below for details.

### [Time Skip]

The time skip excludes a pre-designated amount of time from the scan and then automatically cancels the designation after the time has elapsed.

1. When the scan stops, press and hold [SKIP] key to display the time skip selection screen.
2. Turn [Dial] to select the time you wish to set, and then press [SET] or [SKIP] key to register it. The  icon will be displayed when registered.

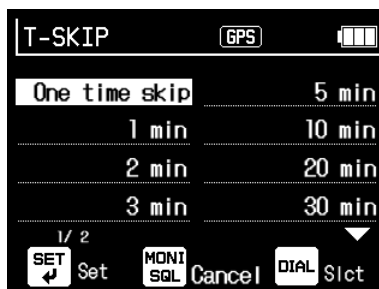

- The time skip designation is automatically canceled when the power is turned off.

The durations that can be set for the time skip are as follows:

One-time/1 minute/2 minutes/3 minutes/5 minutes/10 minutes/20 minutes/30 minutes/60 minutes/90 minutes

One-time: The skip designation is automatically canceled when scanning is stopped.

**[Canceling Skip]**

1. Press [FUNC] key to light up <FUNC> on the display.
2. Press [SKIP] key to display the skip channel edit screen.
3. Turn [Dial] to select "Skip Clear" or "Time Skip Clear," and then press [SKIP] or [SET] key.
4. When the scan type selection screen is displayed, turn [Dial] to select the scan type you wish to cancel, and then press [SKIP] or [SET] key.
5. Depending on the type of scan selected, a different edit screen will be displayed. Operate [SET] key and [Dial] to select the target item, and then select "Yes" for "Do you wish to clear?" and then confirm with [SET] key.

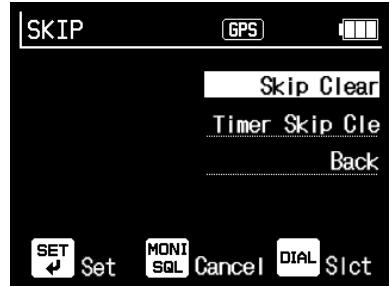

Clear All: This cancels all registered frequency skip settings.

Clear Individual: Select the frequencies to cancel when the registered skip frequencies are displayed.

No: Press [SET] or [MONI] key to return to the previous screen without confirming.

**REFERENCE**

In Memory Mode, a skip can be registered by registering it while a memory channel is displayed, and the skip will be saved in the memory. Press [SKIP] key again to cancel the skip and remove the skip icon.

**■ FM Radio Mode**

This operation is for receiving FM radio broadcasts. The FM radio bands are not included in the VFO frequencies to prevent the scan from stopping the FM radio during All Scan. In VFO Mode, when the Dial is turned and the frequency exceeds 76 MHz, it will shift to 108 MHz.

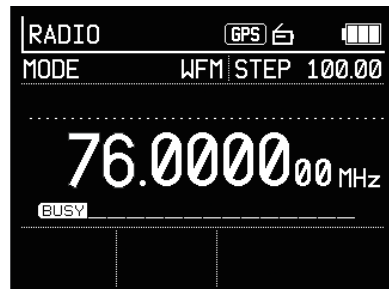
**NOTE:**

FM radio broadcast bands cannot be scanned.

1. Press and hold [MODE] key or enter a frequency between 76 and 108 MHz with the numeric keys in VFO Mode to shift to FM Radio Mode, and the radio icon will be displayed.
2. Turning the Dial displays only 76 to 108 MHz. This can also be entered with the numeric keys in the same way as with VFO Mode. The mode and step are fixed at WFM 100 kHz.
3. The volume in FM Radio Mode is adjusted separately from the other Receive Modes. There is no squelch.  
Turn Ring to adjust the volume while "RADIO" icon is displayed in the upper left corner of the screen.  
The range of adjustment is 33 levels from 0 to 32 with an initial value of 0.

4. When receiving communications or scanning while listening to FM radio, press [MODE], [STEP], [V/M], or [SCAN] key briefly during FM radio reception, or enter a frequency outside of FM broadcasting with the numeric keys.  
It can be determined whether FM Radio Mode is ON by whether the radio icon is displayed. FM Radio Mode operations, such as lowering or muting the broadcast volume when communications are received, can be designated in "Radio Volume Reduction" (P.87) in Set Mode.
5. Press and hold down [MODE] key in FM Radio Mode to return to the previous mode and turn off FM Radio Mode.

**Important**

Please consider that DJ-X100 becomes a "simple FM radio" when entered to FM radio mode. Due to the absence of a squelch, "buzzing" noise is heard on frequencies where there is no broadcast.

When it is shifted to the normal mode while receiving noise, a "buzzing" noise will remain. Turn off FM Radio Mode to mute such noise. When FM Radio Mode volume is set to zero, the "buzzing" sound will disappear also, but the FM receiver circuit is still running and will consume battery by 20% faster.

When you hear a strange noise even squelched, observe a radio icon on the display.



# 5

## MEMORY MODE

This is a Receive Mode in which frequently used frequencies and settings are pre-registered to memory channels and recalled for use. The locations where frequencies are divided into categories for ease of use are called “banks,” and the registered frequencies are called “memory channels.” There is no limit to the number of channel registrations per bank on the receiver, and there is no need to edit the size of the bank.

### NOTE:

No data is registered in Memory Mode in the initial state. Memory Mode operations and Memory Scans cannot be performed without pre-editing the memory channels.

### ■ Types of Memory and How to Use Them

There are four types of memory modes.

- All Memory: All memory channels can be recalled.
- Bank: Memory channels in a designated bank can be individually recalled.
- Bank Link: Memory channels in banks set to be linked can be recalled.
- GPS Memory: Memory channels within a set distance from the current position can be recalled.

Default value: All Memory



### REFERENCE

- Memory channel 000 is reserved for Priority Scan function. The editing operations are the same, but it cannot be used as one of the memory channels.
- FM radio broadcasting cannot be registered in the memory.

### ■ Registering Memory Channels

- Following chapters relating to MEMORY CHANNELS and BANKS are much easily editable using Free editing software posted on our website at No extra cost. For this reason, this manual provides minimal explanation of the manual operations. Operating instructions for the software will be included with the software to be distributed. Please don't spend much time on how to manually set the items, but please read and understand the functions DJ-X100 offers.
- The following content can be registered and edited for memory channels. The receiver does not have any kind of protection for written data. The saved changes are reflected immediately.

[Registerable Data]

- Memory (channel) number
- Frequency
- Mode
- Step
- Communication settings

- Offset step
- Longitude and latitude
- Bank
- Memory name

\* Press [V/M] key to switch to VFO Mode.

1. Press [FUNC] key to light up <FUNC> on the display, and then press [V/M] key to display the memory channel registration screen "WRITE." Items such as frequencies and steps are copied from the VFO setting status when the registration screen is first displayed.

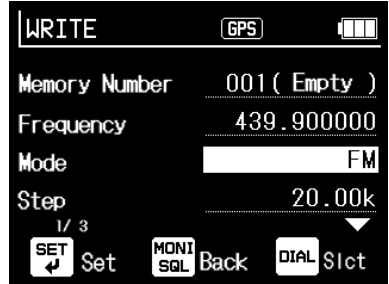

2. Memory Numbers

The initial value is 001, and after registration, the "smallest number available (unused)" will be displayed as "002 (Unused)." Press [SET] key and turn [Dial] on the memory number screen to select the memory number you wish to newly register or edit. The frequency of a registered channel will be displayed in the frame. Press [SET] key to confirm and return to the memory channel registration screen.

REFERENCE

The memory number can be selected as any number from 001 to 999. 000 is the priority channel. Data can be edited immediately by selecting a registered number. No overwrite protection is provided.

3. Frequencies

- (1) Turn [Dial] to select "Frequency," and then press [SET] key.
- (2) Turn [Dial] or operate the numeric keys to enter the frequency.
- (3) Press [SET] key to return to the memory channel registration screen.

REFERENCE

Operate the numeric keys in the same way as when entering frequencies directly in VFO Mode. Read P.31. The FM radio frequencies 76 to 108 MHz and frequencies outside the reception range of the receiver cannot be entered.

4. Modes

- (1) Turn [Dial] to select "Mode," and then press [SET] key.
- (2) When the "Analog," "Digital," and "Data" selection screen appears, turn [Dial] to select. Press [SET] key again to display the respective detailed screens, and then use [Dial] to adjust the mode to your preference. Press [SET] key to confirm and return to the memory channel registration screen. Read this along with "Selecting the Receive Mode" (P.34).

## 5. Steps

- (1) Turn [Dial] to select “Step,” and then press [SET] key.
- (2) When the list of steps is displayed, turn [Dial] to select a value, and then press [SET] key to confirm the selection and return to the memory channel registration screen.



### REFERENCE

There is no function directly related to this set step value for memory channel reception.

### Important

It involves entering long strings of characters after this. These operations take time, and if you mistakenly return even once during the process, the unregistered edits will be lost and cannot be recovered. The edits up to this point can be registered as a new channel by performing the following writing operations. Edits to the remaining items should be performed with the “Edit Memory Channel” operation while frequently saving these edits repeatedly to minimize loss in the event of a mistake.

If you do not wish to save the edits, read “6 Communication Settings” below.

### [Saving Edits (Write Operations)]

- Turn [Dial] to select “Write” on the memory channel registration screen, and then press [SET] key. Select “Yes” on the write confirmation screen, and then press [SET] key to confirm and return to VFO Mode.
- Press [V/M] key to move to Memory Mode, press [FUNC] key, and then press [V/M] key once <FUNC> is displayed. Enter the remaining items when the memory channel information being edited is displayed.

Hereinafter, the same items appear on the edit screen with the same names, whether in VFO Mode or Memory Mode. All operations and functions are the same.

- In VFO Mode, “WRITE” will be displayed on the setting screen; in Memory Mode, [EDIT] will be displayed.

## 6. Communication Settings

Common operations:

Turn [Dial] to select “Communication Settings,” and then press [SET] key. The communication settings screen will be displayed, which varies depending on the Receive Mode. Turn [Dial] to select the item you wish to set, and then press [SET] key. The setting screen described below will be displayed. Use [Dial] and [SET] keys or the numeric keys to set as desired, and then press [SET] key to confirm and return to the registration screen.

Available values and initial values are explained in detail in “Communication Settings for Various Functions” (P.65).



[Analog (FM/NFM)]

- Squelch types (CTCSS, DCS)

They are Continuous Tone Coded Squelch System or Digital Coded Squelch, and a low frequency audio tone or a code is added to the voice signal. Where there are different users on the same radio frequency, CTCSS/DCS system mutes those users who are using a different tone or DCS code. All audio is heard when CTCSS/DCS is turned off.

- CTCSS tone/DCS code

Select the tone or DCS code used by the station you wish to receive on CTCSS or DCS. Obtain information on the station you wish to monitor in advance, or actually receive its signal and check it on the receiver's display. When it is set indiscriminately, nothing will be received. The values that can be set and the initial values are explained in detail in "Communication Settings Analog" (P.66).

[Digital]

The values that can be set and the initial values are explained in detail in "Digital Communication Settings" (P.68).

- DMR: A popular digital land mobile communications format world-wide

The slot, color code, group code, frequency shift, and attenuator can be set. DMR is a TDMA system that alternately splits the 12.5 kHz bandwidth into two time slots, allowing separate communications in each individual slot. Communications can be received in either slot when set to AUTO. The color code is a kind of select call system and is set between 00 and 15. All communications are heard when this is left OFF.

- D-STAR: Japan Amateur Radio League digital format for amateur radio communications.

The code squelch, frequency shift, and attenuator can be selected. All audio is heard when the code squelch is turned OFF.

- C4FM(DN): Recommended digital format for amateur radio by Yaesu Musen Co., Ltd.

The DG-ID, frequency shift, and attenuator can be selected. All audio is heard when the DG-ID is turned OFF.

[Common]

- Frequency shift

Once the shift frequency width and direction are registered, the shift destination frequency can be received by pressing [MONI] key. It is mainly used for receiving relay systems. (e.g., if you register a relay station output frequency of 445.000 MHz and set the shift to -5.000000 MHz, a 440.000 MHz input signal can be received by pressing [MONI] key.)

The initial value is 0.000000. The use of the keys is the same as when entering the frequency. It can also be operated with [Dial]. After setting, "SHIFT-" will be displayed in the lower left corner of the reception screen.

Example: Entering -5 MHz

- (1) On the shift frequency setting screen, press 5 using the numeric keys. +5 will be displayed.
- (2) Press [MODE] key to change to -5.
- (3) Press [SET] key.
- (4) -5.000000 is entered, confirmed, and it returns to the memory channel registration screen.

- Attenuator

When there is a strong signal nearby suppressing or otherwise making it difficult to receive the intended signal, this function reduces the effect of the strong signal and facilitates reception by actually reducing the reception sensitivity. The initial value is OFF, and it can be selected between either 10dB or 20dB. The attenuation becomes greater at 20dB. Press [SET] key, turn [Dial] on the edit screen to select, press [SET] key to confirm, select "Back," and then press [SET] or [MONI] key to return to the memory channel registration screen. The setting value will be displayed in the lower left corner of the reception screen as something similar to "ATT 20."

## 7. Offset step

On the memory channel edit screen, turn [Dial] to select "Offset Step," and then press [SET] key. Turn [Dial] to select "ON" or "OFF," and then press [SET] key to return to the memory channel registration screen.



### REFERENCE

For details on offset steps, read P.73.

## 8. Longitude and Latitude

- Registration is required to use the GPS Memory Scan.
- Longitude and latitude information are easily available from digital maps.
- The distance between the position information entered in GPS or FIX and the position information to be registered in the memory will be displayed on the STEP display from 0.01 km to 999.99 km in 10-m increments.  
When the distance exceeds 999.99 km, "---.--" will be displayed.
- Enter the value in the DEG (Degree) format (decimal scale). Press [MODE] key while entering numerical values to toggle between N and S for north and south latitudes, and E and W for east and west longitudes.
- Numbers are entered in the same way as with frequencies, etc. This operation can be performed with the numeric keys. When the entry is completed, press [SET] key or enter the sixth decimal place to confirm the entry.
- Current position information can also be set from GPS position information.

Turn [Dial] on the memory channel registration screen to select "longitude and latitude," and then press [SET] key.

Turn [Dial] to select "New," and then press [SET] key. Press [MONI] key to cancel.

### [Setting the Latitude]

Turn [Dial] to select "Latitude," and then press [SET] key.

Enter the latitude using the numeric keys, and then confirm to return to the edit screen.

Example: For 35 degrees north, enter 35 using the numeric keys, and then press the SET key. For 41.5 degrees south, enter 41.5 using the numeric keys, press [MODE] key to change N to S, and then press [SET] key.

[Setting the Longitude]

Turn [Dial] to select "Longitude," and then press [SET] key.

Enter the longitude using the numeric keys, and then confirm to return to the edit screen.

Enter the longitude in is the same way as with the latitude.

Press [MODE] key to switch between E (east longitude) and W (west longitude).

[Registering Longitude and Latitude]

Once the numbers are entered, select "Settings" on the LOCATE screen, turn [Dial] to select "Yes" on the "Do you wish to set?" screen, and then press [SET] key to confirm. It will return to the memory channel registration screen.

**NOTE:**

Only entering longitude and latitude values will not register them. Without selecting "Set" on the LOCATE screen, pressing [SET] key, and then selecting "Yes," the value will be removed by any operation that changes the screen.

[Registering from GPS Position Information]

Turn [Dial] to select "Obtain from GPS," and then press [SET] key to automatically set the current position information and return to the memory channel registration screen. The operations for registering longitude and latitude as described above are not required but you must be in a place that can receive GPS signals to use this function.

9. Bank

DJ-X100's banks employs a system in which memory channels in a single area are linked by bank numbers, such as "This is bank A; this is bank B, etc.," not by dividing memory devices into fixed sizes and writing data on them.

- 999 memory channels can be freely registered in the 26 banks from bank A to bank Z without concern for the bank's size.
- The data in one memory channel can be linked and registered in multiple banks. Even if linked with multiple banks, only one memory channel is counted as registered. (Even if 145.000 MHz is linked with Banks A, D, and Z, the number of memory channels remaining is 998, not 996.)
- It is not necessary to assign them in the order starting with A. Any bank can be selected.

[Bank Selection]

On the memory channel registration screen, turn [Dial] to select "Bank Assignment," and then press [SET] key.

- (1) Turn [Dial] to select the bank (A to Z) you wish to use, and then press [SET] key.
- (2) Turn [Dial] to select "ON," and then press [SET] key. Once confirmed, "ON" will be displayed. Do the same for all the banks you wish to link.
- (3) Press [MONI] key or turn [Dial] to select "Back," and then press [SET] key to return to the memory channel registration screen.

### [Changing Bank Names]

For example, when registering the air band frequencies of Los Angeles Airport and Heathrow Airport in Bank A and Bank B, respectively, the banks can be named as “LAX” and “LHR”

- (1) Turn [Dial] on the bank selection screen to select “Change Bank Name,” and then press [SET] key.
- (2) Turn [Dial] to enter characters.  
For details on how to enter characters, see the “Memory Name Function” entry example (P.59).
- (3) After editing, press [SET] key.
- (4) Press [MONI] key or turn [Dial] to select “Back,” and then press [SET] key to return to the bank selection screen.

### 10. Memory Names

Individual memory channels can also be given any name.

- (1) On the memory channel registration screen, turn [Dial] to select “Memory Name (Unset),” and then press [SET] key.  
For details on how to enter characters, see the “Memory Name Function” entry example (P.59).
- (2) After editing, press [SET] key to return to the memory channel registration screen.

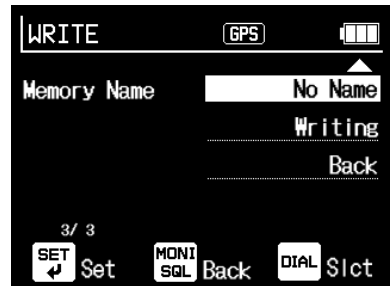

### 11. Write

#### Important

As explained in “Saving Edits (Write Operations),” no edits are saved until this write operations are performed. Use of Free editor software is recommended to avoid complicated manual operations.

All edits are confirmed and saved as memory channel data.

- (1) Turn [Dial] on the memory channel registration screen to select “Write,” and then press [SET] key.
- (2) Turn [Dial] to select “Yes,” and then press [SET] key to complete the memory channel registration and return to the reception screen.

### ● Deleting Memory Channels

\* Press [V/M] key to switch to Memory Mode. This operation can only be performed in Memory Mode.

1. Press [FUNC] key to light up <FUNC> on the display, and then press [V/M] key to display the memory channel registration screen “EDIT.”
2. Turn [Dial] to select “Memory Number,” and then press [SET] key.
3. Turn [Dial] or press the keyboard to select the memory number you wish to delete, and then press [SET] to return to the memory channel registration screen.
4. Turn [Dial] to select “Yes” on the “Do you wish to delete?” screen, and then press [SET] key.
5. Turn [Dial] to select “Yes” on the “Do you wish to delete?” screen, and then press [SET] key to delete the selected memory channel and return to the reception screen. Turn [Dial] to check that the designated channel was removed.

## ■ Operating Memory Mode

This operation cannot be performed unless the memory channel has been registered for the mode to be used. For example, if a memory channel containing position information has not been registered, even if you select GPS Memory Mode, an alert message will be displayed stating that there is no position information.

[Select the Type of Memory Mode]

1. Press and hold down [V/M] key in Memory Mode to display the selection screen for the four Memory Modes.
2. Turn [Dial] to select the type, and then press [SET] or [V/M] key to confirm.  
Some Memory Mode types require multiple [SET] and [V/M] key operations.
3. Turn [Dial] one click to change the channel by one.  
The degree of change can be increased or decreased with the selector acceleration function (P.94) in Set Mode.

Press [V/M] key to exit Memory Mode, remove the memory number icon, and return to VFO Mode.

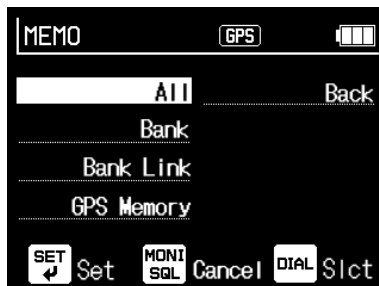

### REFERENCE

Press and hold down [SET] key in Memory Mode to shift to VFO Mode and display the registered memory information.

#### ● All Memory

All memory channels can be recalled.

Select “All Memory” with [Dial] on the Memory Mode type selection screen, and then press [V/M] or [SET] key to recall all memory channels.

#### ● Bank

Memory channels in a designated bank can be individually recalled.

Select “Bank” with [Dial] on the Memory Mode type selection screen, press [V/M] or [SET] key, select the bank you wish to receive on the bank number selection screen with [Dial], and then press [V/M] or [SET] key to recall only the memory channels in the designated bank.

#### ● Bank Link

Memory channels in banks set to be linked can be recalled.

[Registering and Deleting Bank Links]

This sets banks when pre-editing memory channels. For example, register airband channels as Bank A, Train channels as Bank B, navigation channels as Bank C, and so forth.



1. Select “Bank Link” with [Dial] on the Memory Mode type selection screen, and then press [SET] key to display the “Bank Link + Number” setting screen.
2. Turn [Dial] to select the bank link number you wish to edit, and then press [SET] key.
3. Turn [Dial] to select “Add Link” on the bank link edit screen, and then press [SET] or [V/M] key to display the list of pre-registered banks.  
Select “Remove Link” to remove a link, and then perform the same operations.
4. Turn [Dial] to select the bank you wish to add or remove from the bank link, and then press [SET] or [V/M] key. Edited banks will be removed from the list. Repeat this operation to edit the numbers you wish to link.

**REFERENCE**

Unregistered bank link numbers are displayed with strikethrough lines.

5. When completed, press [MONI] key or select “Back,” and then press [SET] key to return to the previous screen.

**REFERENCE**

When all banks have been added, it will automatically return to the previous screen.

**[Starting Bank Links]**

Select “Start Bank Link” on the bank link edit screen to shift to Bank Link Mode. The alphabetical letters and memory number of the registered bank are displayed above MHz.

**[Editing Bank Link Names]**

Easily understood names can be registered for registered bank links.

1. Follow the steps up to step 2 of registering and deleting a bank link, and then select “Bank Link Name” on the edit screen.  
Press [SET] key to display the edit screen. Enter the name manually in the same way as editing a memory channel name, or use the editing software.
2. When editing is completed, press [SET] key to confirm and return to the previous screen.  
Press [MONI] key to cancel the editing and return to the previous screen.

**[Initializing Bank Links]**

Linked registered bank links can be canceled all at once to initialize.

- 1 Select “Initialize” on the bank link edit screen, press [SET] or [V/M] key, and when the “Do you wish to initialize? Yes / No” screen is displayed, turn [Dial] to select “Yes,” and then press [SET] or [V/M] key. Leave “No” as it is, and then press [SET] key to cancel; or press [MONI] key to return to the bank link edit screen.

**● GPS Memory**

The distance is calculated from the longitude and latitude preset to FIX or obtained by the built-in GPS and the longitude and latitude registered in the memory channel, and memory channels within a designated range can be individually recalled. In addition, when it is set to search again, you can automatically limit the recall to nearby frequencies when moving.

**Important**

All GPS-related functions will run only when:

- The lat/long coordination is properly set in advance to FIX Location Information
- OR
- the receiver is receiving enough satellite signals to identify its current location.

1. Select “GPS Memory” with [Dial] on the Memory Mode type selection screen, and then press [V/M] or [SET] key.
2. Turn [Dial] on the GPS memory setting screen to select “Search Range,” and then press [SET] or [V/M] key.
3. Turn [Dial] or enter a numerical value to set the search range. The setting range is 1 to 199 km with an initial value of 20 km.
4. After setting the search range, press [SET] or [V/M] key to return to the GPS memory setting screen.
5. Turn [Dial] to select “Distance to Search Again,” and then press [SET] or [V/M] key.
6. Turn [Dial] to select the distance to search again, and then press [SET] or [V/M] key.  
The initial value is 10 km. The following options to search again can be selected to simplify changes.  
Distance to search again: Do not search again/100 m/200 m/300 m/500 m/1 km/2 km/3 km/5 km/10 km/20 km/30 km/50 km/100 km
7. Turn [Dial] to select “Next,” and then press [SET] or [V/M] key to display the screen for selecting the Memory Mode to search.
8. Turn [Dial] to select the Memory Mode to search, and then press [SET] or [V/M] key to select only that memory channel to search.  
The STEP display replaces the distance display (DIST).

**NOTE:**

- Some types of Memory Mode require multiple [SET] and [V/M] key operations.
- When the target memory channel is not in the search range, “No Corresponding Memory” will be displayed.

## ■ Memory Name

Memory channels registered in Memory Mode can be given names of up to 28 characters, including numbers, alphabetical letters, and symbols.  
Registering a name with a call sign or broadcast station name makes it easier to find the memory channel.

### NOTE:

Just briefly go through this part. Use the editor software for practical memory name editing.

### ● How to Edit Memory Names

1. Press [FUNC] key in Memory Mode to light up <FUNC> on the display, and then press [V/M] key to display the memory channel registration screen "EDIT."
2. Turn [Dial] to select "Memory Name (Unset)," and then press [SET] key.
3. When the memory name setting screen is displayed, operate the keys and [Dial] to enter characters.  
For a list of characters that can be entered, see P.60.

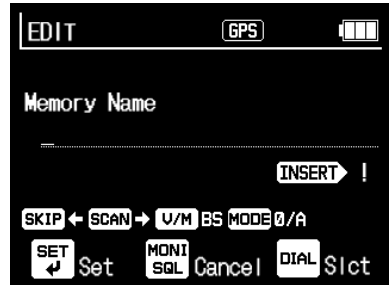

#### [How to Enter Characters]

Press [MODE] key to select the type of characters to enter.  
Press [STEP] key to change between upper and lower case (alphabetical letters).  
Turn [Dial] clockwise to display the characters in regular succession. Turn the dial counterclockwise to display the characters in reverse.  
Press [SCAN] key to move the cursor one character to the right.  
Press [SKIP] key to move the cursor one character to the left.  
Use [SCAN] key to move cursor one space rightward, then press [V/M] key to delete a character at left

4. When the entry of characters is completed, press [SET] key to finish editing. Select "Write" on the memory edit screen and perform the "Write Operations" as described above. The edited characters will be lost if this is not performed.



### REFERENCE

The registered memory name will be displayed above the frequency display.

Example: Writing "LAX TOWER 1"

Move to the memory name setting screen described in 3 above.

- (1) Press [MODE] key to select "Alphabet (or Full alphabet)" and press [SET] key, and rotate [Dial] to select L.
- (2) Press [SCAN] key to move the cursor the right, and rotate [Dial] to select A.
- (3) Repeat above to enter characters. To make space between LAX and TOWER, press [SCAN] key twice.

(4) To enter 1, press [MODE] key and select Numbers (or Full numbers) and press [SET] again.

When completed to enter 1 at the end, press [SET] key. Display switches to Memory Name and LAX TOWER1 is displayed.

(5) Rotate [Dial] to select Writing and press [SET] key so that a dialog <Memory?> will appear.

(6) Rotate [Dial] to select <Yes>, and press [SET] to return to the stand-by state. Observe that LAX TOWER1 is displayed above frequency.

■ List of Entry Characters

When [MODE] key is pressed, the following types of characters can be selected.

For all registration settings, up to 14 full-width characters or 28 half-width characters can be entered.

Press [STEP] key while entering alphabetical letters to switch between entering them in uppercase and lowercase. (Initial value is uppercase.)

When full-width katakana or full-width hiragana are input, press [STEP] key to select the kanji for that character. JIS-1 and JIS-2 characters are available. See Japanese instruction manual at [www.alinco.co.jp](http://www.alinco.co.jp) HP for details.

Available characters

- Half-width symbols
- Half-width numbers
- Half-width alphabet
- Full-width symbols
- Full-width numbers
- Full-width alphabet in addition
- Full/half-width Hiragana
- Full-width Katakana and Japanese Kanji characters are usable

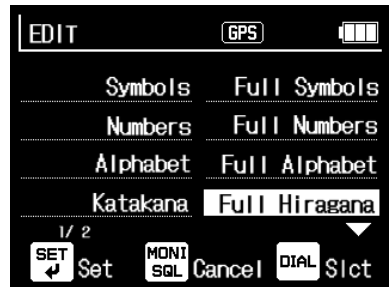

NOTE:

Pronunciation symbols such as umlaut and cédille are not supported.

● Enterable Characters

Japanese characters are omitted from the list below.

DJ-X100T/E supports JIS1/JIS2 Standard Kanji.

- Half-width symbols

Space! " # \$ % & ' ( ) \* + , - . / : ; < = > ? @ [ \ ] ^ \_ ` { | } ~

For supported Kanji characters, please refer to the PDF copy of Japanese DJ-X100 instruction manual available from alinco.co.jp site.

- Half-width numbers

0 1 2 3 4 5 6 7 8 9

- Alphabetical letters

A B C D E F G H I J K L M N O P Q R S T U V W X Y Z

- Full-width symbols

(Space) 、 。 , . . : ; ? ! " ° ´ ˘ ˆ ˉ ˉ \_ \ > > 〃 全 々 々 〇 — — - / \ ~ || | ... .. ‘ ’ “ ” ( ) [ ] [ ] { } < > << >> 「 」 『 』 【 】 + - ± × ÷ = ≠ < > ≤ ≥ ∞ ∴ ♂ ♀ ° ´ ˘ ˆ ˉ ˉ ˉ ° ¸ ¥ \$ € £ % # & \* @ \$ ☆ ★ ○ ● ◎ ◇ ◆ □ ■ △ ▲ ▽ ▼ ※ 〒 → ← ↑ ↓ ■ ∈ ∃ ⊆ ⊇ ⊂ ⊃ ⊃ ∪ ∩ ^ ∨ ⊃ ⊃ ⇒ ⇔ √ √ ∞ ∞ ∴ ∴ ∫ ∫ Å % # b ♪ † ‡ ◻ ◯

- Full-width numbers

0 1 2 3 4 5 6 7 8 9

- Full-width alphabet

A B C D E F G H I J K L M N O P Q R S T U V W X Y Z

- Capital Letter/Smal Letter conversion

Press [STEP] key to switch between capital letter and small letter during half-width or full-width alphabets is input. (The default is capital letter.)

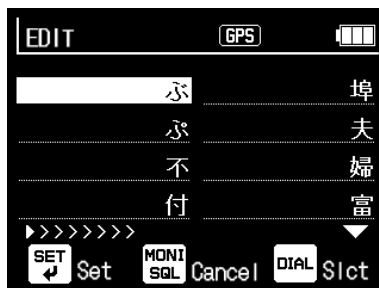

## ■ Memory Scan

Scans will not run unless the memory channels are pre-registered. As explained in the memory channel section, GPS Memory Scans require GPS reception or the registration of FIX position information.

There are six types of memory scans:

- All Memory Scan
- Bank Scan
- Bank Link Scan
- GPS Memory Scan
- Priority Scan
- Shift Scan

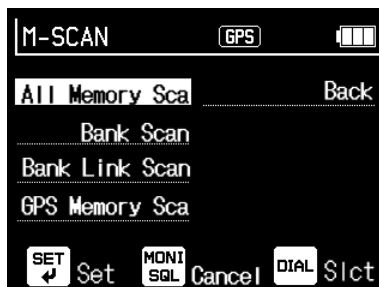

[Basic Scanning Operations]

Operate [V/M] key to switch to Memory Mode.

Hold down [SCAN] key to display the scan type selection screen. Perform the operations described below to start a designated scan. The display while scanning varies depending on the mode, but the dot and MHz in the frequency display will blink except for Priority Scans.

Press [MONI] key to pause, and it will resume scanning after a short time. Press [SCAN] key to stop scanning.

Press [SCAN] key until the scan type has changed once again to start scanning in the currently selected mode.



### REFERENCE

Press [SCAN] key in the selected Memory Mode to start scanning in the selected Memory Mode.

#### ● All Memory Scan

Scans all registered memory channels.

Hold down [SCAN] key, select “All Memory Scan” on the scan type selection screen with [Dial], and then press [SCAN] or [SET] key to start.

#### ● Bank Scan

Repeatedly scans only the memory channels of one selected bank.

While scanning, the registered bank’s alphabetical letters and the memory channel number will be displayed above MHz.

Hold down [SCAN] key, select “Bank Scan” on the scan type selection screen with [Dial], press [SET] key, select the bank you wish to scan on the bank number selection screen with [Dial], and then press [SCAN] or [SET] key to start.

#### ● Bank Link Scan

Allows multiple banks to be linked and scanned repeatedly.

It scans in the order of bank number, not in the order in which they were added to the link. It will not run unless the bank link is registered. See “Registering a Bank Link” (P.56) to pre-register.

**REFERENCE**

Bank links can also be registered from the scan type selection screen. The operations are the same as explained on P.56, except that [V/M] key changes to [SCAN] key.

1. Hold down [SCAN] key, select “Bank Link Scan” with [Dial] on the scan type selection screen, and then press [SET] key to display “Bank Link + Number” setting screen.
2. Turn [Dial] to select the bank link number you wish to scan, and then press [SET] key.
3. Turn [Dial], and then select “Start Link Scan” to start scanning.

While scanning, the dot and MHz in the frequency display will blink, and the alphabetical letters and memory number of the registered bank will be displayed.

**● GPS Memory Scan**

This calculates the distance from the longitude and latitude information obtained by the built-in GPS or fixed longitude and latitude information registered to the memory channel, and then scans only the memory channels within the set range. In addition, when it is set to search again, reception can be automatically limited to nearby frequencies while moving. For example, obtain the positions of the towers at Haneda Airport, Narita Airport, and Yokota Air Base from internet maps, and write the longitude and latitude when the respective air band frequencies are edited in the memory too. Set the search range to 10 km and the range to search again to 20 km. If you go near Yokota Air Base and perform a GPS Memory Scan, it will automatically search and scan only channels that have written position information within 10 km of Yokota. If you start to move from Yokota toward Haneda, it will search the memory channel again after reaching a distance of 20 km. Yokota’s frequency will be removed from the scan, and when within 10 km of Haneda (the position to search again), Haneda’s frequency will become subject to the scan. Similarly, when heading from Haneda toward Narita, the receiver will search again every 20 km and automatically search for any linked memory in the vicinity. When the positions of radio stations between airports are also registered, they can be searched again while moving, and their signals can also be scanned automatically.

**REFERENCE**

This scans with the registered position information. When it is set to search all memory, there is no need to switch banks while scanning.

**NOTE:**

- It will not run when the position information cannot be obtained by GPS.
- This will not run unless the longitude and latitude are written to the memory channel.

1. Hold down [SCAN] key in Memory Mode to display the scan type selection screen.
2. Turn [Dial] to select "GPS Memory Scan," and then press [SET] or [SCAN] key.
3. Turn [Dial] on the GPS Memory Scan setting screen to select "Search Range," and then press [SET] or [SCAN] key.
4. Turn [Dial] or enter a numerical value to set the search range. The setting range is 1 to 199 km with an initial value of 20 km.
5. After setting the search range, press [SET] or [SCAN] key to return to the GPS Memory Scan setting screen.
6. Turn [Dial] to select "Distance to Search Again," and then press [SET] or [SCAN] key.
7. Turn [Dial] to select the distance to search again, and then press [SET] or [SCAN] key. The initial value is 10 km. The following options to search again can be selected to simplify changes.  
Distance to search again: No search/100 m/200 m/300 m/500 m/1 km/2 km/3 km/5 km/10 km/20 km/30 km/50 km/100 km
8. Turn [Dial] to select "Next," and then press [SET] or [SCAN] key to display the screen for selecting the Memory Mode to search.
9. Turn [Dial] to select the Memory Mode to search, and then press [SET] or [SCAN] key to start scanning.

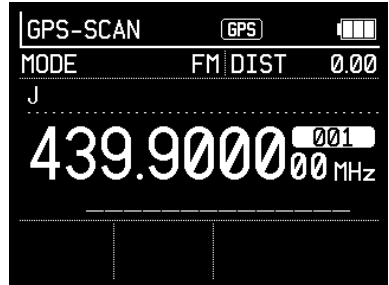

While scanning, the dot and MHz in the frequency display will blink, and [GPS-SCAN] will be displayed in the upper left corner of the receiver's Operation Mode display. Also, the STEP display replaces the distance display (DIST).

**NOTE:**

- Some types of Memory Modes require multiple [SET] and [SCAN] key operations.
- When the target memory channel is not in the search range, "No Corresponding Memory" will be displayed.

**● Priority Scan and Shift Scan**

This is the scan mode previously explained for VFO Scans. This also runs in Memory Mode.

Priority Scans receive the frequency registered in memory channel 000 at regular intervals during memory channel reception.

Shift Scans receive the memory frequency within the shift width registered to the memory channel and the shift destination frequency alternately at high speed.

- The list will only be displayed when the Priority Scan and Shift Scan have each been set.
- Priority Scans do not stop unless OFF has been selected on the scan type selection screen. Priority Scans do not stop by operating [SCAN] key.
- Select [SET] or [SCAN] key on the scan type selection screen to immediately start a "Shift Scan." Press [SCAN] key briefly to stop it.

To resume, hold down [SCAN] key, and then select "Shift Scan" again.



# 6

## Functions

### ..... Communication Settings (CONFIG) .....

The contents of the “Communication Settings” previously explained in Memory Mode can be easily changed. Operating in Memory Mode temporarily rewrites the communication settings for that channel. With the settings for such selective reception methods as tone squelch and user code, and their tones, frequency shifts, attenuators, etc., the menu displayed will vary depending on it being analog, digital, or data.

1. Press [FUNC] key to light up <FUNC> on the display.
2. Press [MODE] key to display the communication settings screen. The contents displayed will vary depending on the Receive Mode.
3. Turn [Dial] to select the item you wish to set, and then press [SET] or [MODE] key.
4. When the detailed setting screen is displayed, turn [Dial] to select the item you wish to set, and then press [SET] or [MODE] key. To cancel, press [MONI] key or turn [Dial] to select “Back,” and then press [SET] key to return to the previous screen.
5. Press [MONI] key or turn [Dial] to select “Back,” and then press [SET] or [MODE] key to return to the previous screen.

#### REFERENCE

While in operation, icons may be displayed at the bottom of the setting screen depending on the mode or item. They explain such operations as turning a function ON or OFF with [MODE] key or immediately returning to the initial value (INIT) by pressing [STEP] key.

#### ■ Common

These are the communication setting items in all Receive Modes.

When AM, NAM, AIS, ACARS, 12kHzIF (W), or 12kHzIF (N) is selected, only the following two items will be displayed.

#### [Frequency Shift]

This is the shift width setting to shift the receiving frequency when [MONI] key is pressed for a frequency currently being received.

It is the width and direction of the uplink and downlink frequencies of the relay station.

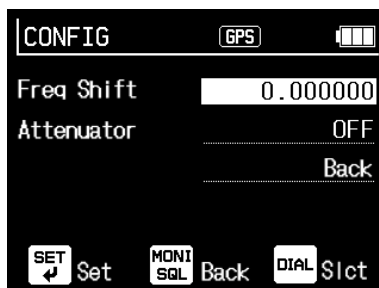

\*This is the display shown in AM/NAM and Data Mode.

Set value: 0 to ± 99MHz  
Initial value: 0  
Press [MODE] key to toggle between plus and minus.

[Attenuator]

This function reduces the reception sensitivity to make the desired signal easier to hear by reducing disturbances when the reception is affected by a station with a strong signal on a nearby channel (suppression), or in case like FM broadcasting is heard in an Aeronautical Radio band (intermodulation). The attenuation is greater at 20 dB.

Set value: OFF, 10 dB, 20 dB  
Initial value: OFF

 REFERENCE

The attenuation of the attenuator varies depending on the receiving frequency.  
DJ-X100 does not have the function to “increase sensitivity” like that of preamplifiers.

■ Analog

● FM/NFM

[Squelch Type]  
Set value: OFF / CTCSS / DCS  
Initial value: OFF

This setting is for using CTCSS (Continuous Tone-Coded Squelch System) and DCS (Digital Coded Squelch), which are often used to stand by and receive specific stations in analog communications. Select the squelch type to use with [Dial].

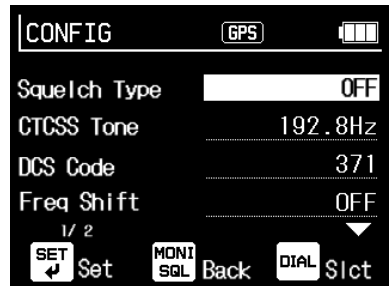

\*This is the display shown in FM/NFM.

NOTE:

The normal squelch level should also be pre-adjusted properly when using the tone squelch or DCS. When the normal squelch is left open, it will take longer to operate the tone squelch and DCS.

 REFERENCE

All CTCSS tones and DCS coded signals can be received when the squelch type is turned off. This setting is used when you wish to avoid interference and only stand by for the destination's signal.

[CTCSS Tone]

This is a decoder setting. The squelch will open when a signal superimposed with the same tone frequency as the set value is received. The tone squelch is known as PL (Private Line) of Motorola radios.

The receiver supports 50 tones.

Set value:	67.0	69.3	71.9	74.4	77.0	79.7	82.5	85.4	88.5
	91.5	94.8	97.4	100.0	103.5	107.2	110.9	114.8	118.8
	123.0	127.3	131.8	136.5	141.3	146.2	151.4	156.7	159.8
	162.2	165.5	167.9	171.3	173.8	177.3	179.9	183.5	186.2
	189.9	192.8	196.6	199.5	203.5	206.5	210.7	218.1	225.7
	229.1	233.6	241.8	250.3	254.1				

(Hz)

Initial value: 67.0 Hz

[DCS Code]

The receiver supports 106 types of DCS code.

Set value:	017	023	025	026	031	032	036	043	047
	050	051	053	054	065	071	072	073	074
	114	115	116	122	125	131	132	134	143
	145	152	155	156	162	165	172	174	205
	212	223	225	226	243	244	245	246	251
	252	255	261	263	265	266	271	274	306
	311	315	325	331	332	343	346	351	356
	364	365	371	411	412	413	423	431	432
	445	446	452	454	455	462	464	465	466
	503	506	516	523	526	532	546	565	606
	612	624	627	631	632	654	662	664	703
	712	723	731	732	734	743	754		

Initial Value : 017

■ Digital

● DCR, NXDN

[Sequence Code(SC)]  
 (Not compatible with DJ-X100T)  
 Set value: 001 to 511 / AUTO  
 Initial value: 228



REFERENCE

Press [MODE] key on the code selection screen for AUTO, or press [STEP] key to return the changed value to the initial value.

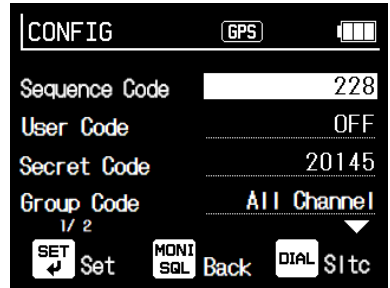

\*This is the display shown in DCR and NXDN DJ-X100E.

[User Code / Radio Access Number]

This function is similar to analog CTCSS, and all communications that use codes can be received when it is turned off. This setting is used to avoid interference and stand by only for the intended signal. UC stands for DCR and NXDN.

Set value: OFF / 001 to 511  
 Initial value: OFF

[Secret Code]

This code is set for communication in which signals other than the same code are received but doesn't sound like a voice.

Set value: OFF / 00001 to 32767  
 Initial value: OFF

This function operates in DCR and NXDN 32,767 combination codes detection only, that is not encrypted codes.

[Group Code]

This code is used in DCR and NXDN that is assigned to each group when calling a specific group.

Set value: All stations / 00001 to 65535  
 Initial value: All stations

● DMR

[Slots]

Both can be received when set to AUTO.  
 Set value: AUTO / 1 / 2  
 Initial value: AUTO

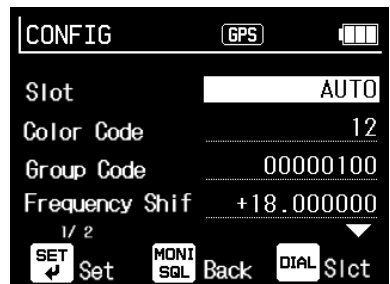

\*This is the display shown in DMR.

**[Color Code]**

This is similar to DCR/UC or NXDN/RAN, and OFF receives all signals.

Set value: OFF / 00 to 15

Initial value: OFF

**[Group Code]**

This function is similar to the group call function of DCR/NXDN. When it is set to all stations, it will receive all signals.

Set value: All stations / 00001 to 65535

Initial value: All stations

**● dPMR:**

**This is a digital radio communication standard designed for professional and private mobile radio applications.**

**● D-STAR:**

**This is a digital communication mode that is often used in Ham Radio communications and for which JARL has established standards. The receiver only supports receiving voice communications.**

**[Code Squelch]**

This function is similar to the UC/RAN/Color code, and OFF receives all signals.

Set value: OFF / 00 to 99

Initial value: OFF

**● C4FM (DN):**

**It supports the DN Mode reception of digital communications proposed by Yaesu Musen Co., Ltd.**

**[DG-ID]**

This is the code used when calling stations with matching numbers. All stations can be received when it is off.

Set value: OFF / 0 to 99

Initial value: OFF

..... F-COUNT (Frequency Counter) .....

1. Press [FUNC] key to light up <FUNC> on the display.
2. Press [SET] key to shift to the F-COUNT Mode.  
Only the dot and MHz will be displayed as it searches for a strong signal.
3. When a strong signal is found, the frequency will be displayed.
  - When a signal is lost, the detection will be newly started.
  - Press any key to exit.
  - Hold down [SET] key to copy to VFO Mode for reception when the frequency is displayed. It runs in FM mode. When a signal is detected, move to VFO and change the mode if necessary.  
It runs in FM Radio mode also but the signal must be very strong, such as near a transmitting station.

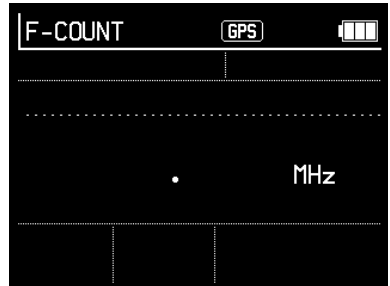

**NOTE:**

- Depending on the type of radio wave, it may not be detected.
- The operating frequency of F-COUNT is 50 MHz to 470 MHz.
- This detects radio waves in a different way than normal reception. It will not run unless there are persons operating radios nearby, or if you are receiving in the immediate vicinity of a transmitting station or radio station. Even when it can be heard well, it may not run with signals as small as FM broadcasting.
- This also responds to noise. Malfunctions may occur near noise-producing devices, such as PCs.
- The resolution of F-COUNT is 1 kHz.
- The responding electric field strength varies depending on the frequency. It may not be possible to detect a signal which would be displayed fully in the S-meter.

## Quick Recall

The reception status itself, including not only the frequency but also the display, memory channels, and Set Mode items can be easily recalled by holding down the numeric keys. Numeric keys 1 to 9 can be registered.

As the receiver is used to minutely switch between such display screens as position and GPS along with the Receive Modes, steps, etc., this is a convenient function that enables recalling with a touch when frequently used statuses or Set Mode items have been registered.

### ■ Quick Recall Initial Value

The following statuses are registered in the default state. It will return to this status when the part reset (P.101) or all reset (P.102) described below are realized.

Key	Frequency	Mode	Step	Offset	Shift	Communication Settings
1	118.000000	AM	25.00k	OFF	0.000000	Default
2	145.000000	NFM	12.50k	OFF	0.000000	Default
3	145.200000	FM	5.00k	OFF	0.000000	Default
4	156.800000	FM	50.00k	OFF	0.000000	Default
5	161.975000	AIS	25.00k	OFF	0.000000	Default
6	300.000000	AM	100.00k	OFF	0.000000	Default
7	433.000000	NFM	12.50k	OFF	0.000000	Default
8	442.000000	FM	5.00k	OFF	0.000000	Default
9	351.287500	DCR	6.25k	OFF	0.000000	Default

### ■ Registering and Recalling Quick Recall

1. Referring to the conditions below, display the reception status and items you wish to register on the reception screen and press [FUNC] key. When <FUNC> does not light up on the display, it is not a status or item that can be registered.
2. Hold down any numeric button from 1 to 9 while <FUNC> is lit up to produce a beeping sound and record the status.
3. Hold down a numeric key from 1 to 9 while receiving to recall the recorded status.
4. If you wish to change the registration, perform the same operation to overwrite the number that is unneeded.

The registration can be overwritten but not deleted.

Hold down [0] key to display the list of registered quick recalls.

Press [MONI] key to return to the reception screen.

### ■ Quick Recall Registered Contents

Screens that can be recalled by simply pressing a key once, that do not display a FUNC icon when [FUNC] key is pressed, that are for entering numerical values, and other such screens may not allow quick recall designation, or even if the designation is possible, the status displayed may be slightly different, such as having a different set value when recalled.

Status	Main items that can be registered
VFO Mode	Frequency, Receive Mode, Frequency step, Offset step, Communication settings, Display Mode
VFO Scan Mode	Scan type selection screen, Program Scan selection screen, Link Scan selection screen
During an All Scan	Scan start frequency, Receive Mode, Frequency step, Offset step, Communication settings, Display Mode
During an MHz Scan	Scan start frequency, Receive Mode, Frequency step, Offset step, Communication settings, Display Mode
During a Program Scan	Scan number, Display Mode
During a Link Scan	Link Scan number, Display Mode
Memory Mode	Memory Mode selection screen, Bank selection screen, Bank link selection screen, and GPS search setting screen
In All Memory Mode	Memory number, Display Mode
In Bank Memory Mode	Bank, Memory number, Display Mode
In bank link Memory Mode	Bank link number, Bank, Memory number, Display Mode
In GPS Memory Mode	GPS search settings (Search Memory Mode, search range, distance to search again), Display Mode
Memory Scan Mode	Memory scan type selection screen, bank selection screen, bank link selection screen, GPS search setting screen
During an All Memory Scan	Display Mode
During a Bank Memory Scan	Bank, Display Mode
During a Bank Link Scan	Bank link number, Display Mode
During a GPS Memory Scan	GPS search settings (Search Memory Mode, Search range, Distance to search again), Display Mode
Settings	Each level menu or each setting screen



# 7

## Useful Functions

### Key Lock

This function prevents the unintentional operation of keys and dials when in use or carrying.

Hold down [FUNC] key to lock. While locked, the <key> icon lights up to the left of the battery icon. Hold down [FUNC] key again to cancel.

Volume control is also operated by [Ring] and [MONI] key in key lock.

It can also be changed in the “Key Lock Range Settings” in Set Mode. See P.95.



### Offset Step

This is a convenient function that adds 1/2 of the frequency step that has been set for the receiving frequency, thereby eliminating the step-switching operation.

Suppose your VHF commercial radio band has a step of 20 kHz; until 147.980, the steps are even, as in 940, 960, 980, etc., and from 148.010, the steps are odd, as in 148.030, 050, etc. Hold down [STEP] key during an even-numbered step to switch to an odd-numbered step.

When the offset step is canceled, it is received in even-numbered steps.

Initial value: OFF

Hold down [STEP] key to enable the offset step, and “OFFSET STEP” will be displayed below the receiving frequency. Repeat the same operation to disable and the display will disappear.



## ●●●●●●●●●● GPS Display ●●●●●●●●●●

The GNSS (Global Navigation Satellite System) is the collective name for satellite positioning systems, such as GPS in the United States, Quasi-Zenith Satellite System (QZSS) in Japan, and Galileo in the European Union.

The following functions will not run in environments that are unreceptive to positioning satellites, or when the “Position System Setting” (P.93) within “Position/Distance” in Set Mode is set to OFF or FIX.

**REFERENCE**  
 For the receiver and throughout the text, GNSS is described as the commonly used term of GPS.

**NOTE:**







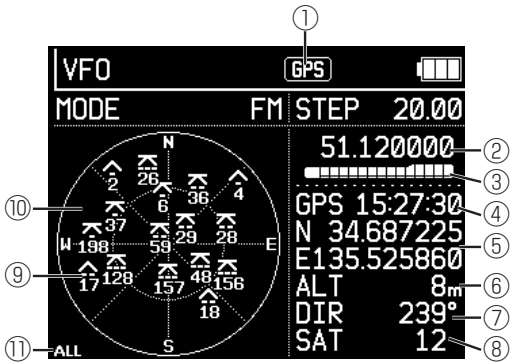



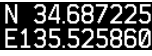
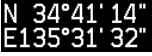

- As the GNSS is developed, operated, and managed by each country, for political purposes, some satellite signals may stop transmitting without prior notice due to such factors as the degradation of positioning accuracy, satellite coordination, testing, and trajectory correction, and abnormal radio waves may be transmitted from the satellites for maintenance, etc. In such cases, it may cause malfunction or the significant degradation of positioning accuracy.
- Significant degradation of positioning accuracy (e.g., position jumps) may occur due to the placement of the receiving satellites, electromagnetic interference, a multipath of received signals, or other factors.
- Even in good environmental locations, the positioning accuracy may degrade due to the placement of the receiving satellites.
- The GPS antenna is built into the top of the receiver. Use the receiver with the top facing upward. Positioning accuracy may degrade when the receiver is laid on its side.
- An external antenna for GPS cannot be connected. External antennas cannot receive GPS signals.

It displays the longitude and latitude, altitude, time, and number of satellites obtained by GPS. It also visualizes this information by mapping it on a sky map. It shows the azimuth and elevation angle where the satellite is located, the satellite number, and the reception status.

● **Display Examples (GPS Display)**



## Explanation

No.	Name	Function
①		GPS lit up: The GPS function is activated when GPS signals are received. GPS blinking: It is unable to receive a GPS signal in this status; the receiver's GPS function will not run.
②		Receiving Frequency of the receiver
③		S-Meter
④		Time obtained from GPS
⑤	 	Longitude and latitude in DEG (Degree) and DMS (Degree, Minute, Second) Upper: Latitude / Lower: Longitude Default is DEG. Press <FUNC> to display DMS coordinations. <FUNC> icon unlit: DEG format / lit up: DMS form
⑥		This is the current altitude of the receiver's location. At least four satellites must be acquired. Even after acquiring them, it may take several minutes for the display to become accurate.
⑦		The true azimuth of movement (unit: degree) true north 0°/east 90°/south 180°/west 270°
⑧		The number of satellites receiving data used for the receiver's GPS function
⑨		<ul style="list-style-type: none"> <li>Satellite status           <ul style="list-style-type: none"> <li>: Tracking (receiving)</li> <li>: Incomplete</li> </ul> </li> <li>Satellite signal strength           <ul style="list-style-type: none"> <li>-: Weak or unable to receive data completely</li> <li>--: Medium</li> <li>---: Strong</li> </ul> </li> <li>Satellite number</li> </ul>
⑩		Sky map Circle center: 90-degree elevation angle (zenith) Inner circle: 45-degree elevation angle Outer circle: 0-degree elevation angle (horizon) N: North S: South E: East W: West
⑪		Satellite types to be displayed

- This is set to GPS through the position system setting. Read P.93 for the settings of the position system setting. The GPS icon will start blinking.  
When the GPS acquires a signal, the GPS icon will change to being lit up and the position and other information will be displayed.
- Press [SET] key on the reception screen to switch to Set Mode.
- Turn [Dial] to select "Display Mode," and then press [SET] key.
- Turn [Dial] to select "GPS Display," and then press [SET] key to switch to the GPS display screen. Select "Back" to stop the operation.
- To return to the basic display screen, press [SET] key to select "Display Mode" on the Set Mode screen, press [SET] key again, turn [Dial] to "Basic Display," and then press [SET] key.



**REFERENCE**

- Though the GPS icon normally changes to being lit up in tens of seconds, it may take several minutes depending on the operating environment.
- Depending on the surrounding environment of the location or the building of use, it may not be able to receive signals from GPS satellites. It may be unable to acquire GPS indoors, underground, in urban areas with many tall buildings, or in tunnels, but this is not an abnormality. The receiver receives radio waves directly from satellites. If the position display seen on a cell phone cannot be seen on the receiver, it is not an abnormality
- To determine if the GPS function is malfunctioning, find a location in advance, such as a nearby park or riverbed, where the sky is wide open and GPS is sure to be received. If it seems that it is not receiving GPS well enough or is malfunctioning, try to determine if there is reception at that location. GPS reception may be difficult when it is raining or in other inclement weather conditions.

**● Satellite Display**

Satellites mapped on the sky map can be displayed for each satellite positioning system. When many satellite icons are displayed, their individual information will be easier to see.

1. Press [FUNC] key to light up <FUNC> on the display.
2. Turn [Dial] while <FUNC> is lit up to change the satellite to be displayed.  
The type of satellite is displayed in the lower left corner.

Selection items: ALL, GPS, GLO, GAL

ALL: All satellites will be displayed.

GPS: The GPS and QZSS satellites will be displayed.

GLO: Only the GLONASS satellites will be displayed.

GAL: Only the Galileo satellites will be displayed.

Initial value: ALL



**REFERENCE**

OFF will be displayed when set to OFF or FIX in the “Position System Setting” (P.93) under “Position/Distance” in Set Mode.

## Position Display

When a signal that is decodable by the receiver is received in communications containing position information, the current position obtained by the receiver's GPS or the manually entered FIX info will be analyzed and its positional relationship will be displayed. These communications are easily received by AIS (Automatic Identification System). A large number of signals can be received in coastal areas with ports and where vessels navigate, and signals may also be received inland if an external antenna is installed or the receiver is moved to a location with a good vantage point, such as a mountaintop or the top of a tall building.



### REFERENCE

The frequency can be changed by turning [Dial] on the position display screen but not by key entry.

Turn OFF the battery save to receive data signals. The reason for this is that when BS runs during signal reception, the data will be lacking and less data will be available for decoding. Press [SET] key on the reception screen to set "Battery Save" to OFF in the "Power" menu in Set Mode. (P.95)

### ● AIS Reception

AIS ch1 (161.975MHz) is preset to the quick recall ch 5 as default. Press and hold [5] key for quick access. See next page for meanings of display and icons. The following explains how to manually set the Position setting display by taking AIS as an example.

1. In VFO Mode, set the receiving frequency to 161.975 MHz or 162.025 MHz.
2. Press [MODE] key, select "Data" with [Dial], press [SET] key, select "AIS" with [Dial], and then press [SET] key to confirm. It will return to the reception screen.
3. Press [SET] key, use [Dial] to select "Display Mode," use [SET] key to select "Position Display" on the display settings screen, and then press [SET] key. The screen will change to the position display screen.
4. Press [SET] key, select "Position/Distance" in Set Mode with [Dial], press [SET] key, press [SET] key again for "Position System Settings" on the setting screen to select GPS or FIX (manually pre-enter position information), press [SET] key to confirm, and then press [MONI] key twice to return to the reception screen. The GPS or FIX icon will be displayed.
5. When an AIS signal is received, the icon of a mobile station or base station will be displayed, and the direction and distance to that station will be displayed in the STEP display for 10 seconds or until another signal is received. The display time is fixed at 10 seconds in AIS Mode, regardless of the time setting for message reception described below. To stop the position display, press [SET] key, operate [SET] key and [Dial] in the "Display Mode" to change the "Position Display" to "Basic Display," and then confirm with [SET] key.

Meanwhile, when the AIS Mode is left as it is without changing the Receive Mode or frequency, the direction and distance will be displayed in the STEP display when a signal is received.

**REFERENCE**

Icons such as for moving objects are not displayed under the following conditions, except when there is no signal received.

- The GPS icon or FIX icon is blinking (no position information)
- The position system setting is set to be OFF
- The screen is deleted (the numeric key 1 operations described below)

When Display Mode is switched to position display again, it will not be deleted.  
When the power is turned off, it will no longer be displayed. It cannot be saved.





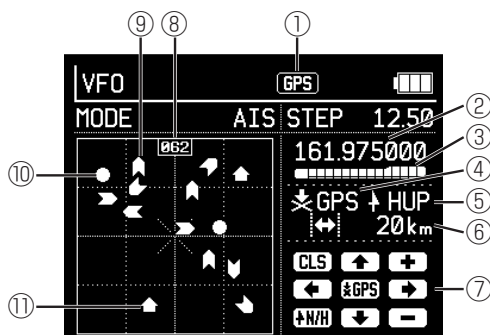

\* When the frequency and Receive Mode have been set in the same manner, the icons of moving objects, etc. will automatically be displayed in the display explanations below when communications with position data are received

**● Examples of Display (Position Display)**



Explanation

No.	Name	Function
①		GPS lit up: When the receiver is acquiring a position via GPS GPS blinking: When the receiver is not acquiring a position via GPS FIX lit up: When the longitude and latitude is being set manually in FIX FIX blinking: When the longitude and latitude is not being set in FIX
②	<b>161.975000</b>	The position data signal receiving frequency
③		S-meter: the more segments displayed, the stronger the signal will be
④		Information at Center of Display GPS: Displayed when the position information received from GPS or entered manually is at the center of the screen MOV: Displayed when your position information is off-center, such as when looking at a different frame (grid) with the numeric key operations described in ⑦ below
⑤		Direction above the display screen NUP: Fixes the top of the display screen to the north HUP: Direction of movement is upward; the direction varies

⑥		Distance of one side of the grid (frame displaying dotted line) Initial value is 5 km; can be changed to 10 m/20 m/50 m/100 m/200 m/500 m/1 km/2 km/5 km/10 km/20 km/50 km/100 km/200 km/500 km (press numeric key 3 to go down, press 9 to go up).
⑦		Operation Guide for Numeric Keypad (For details, read the next section on keyboard operations during position display.)
⑧		On-Screen Azimuth N: Fixed display when NUP Numeric: Azimuth is displayed (000 for north) when HUP
⑨		Mobile stations with an identified direction of movement (In the example on the left, the upper side is the direction of movement)
⑩		Fixed stations or suspended mobile stations
⑪		Base station

#### [Keyboard Operations During Position Display]

Key	Instruction
1	Select "Yes" with [SET] key to confirm once "Do you wish to clear the screen?" is displayed, and the icon being displayed will be cleared and it will be updated with the newly received information.
2	The screen can be moved down by 1/2 grid.
3	Decrease grid distance by 1 level
4	Move the screen to the right by 1/2 grid
5	Switch the center of the display to the GPS position coordinates
6	Shift the screen to the left by 1/2 grid
7	Switch the display direction to either north or the direction of movement.
8	Move the screen up by 1/2 grid
9	Increase the grid distance by 1 step

### ..... Receiving Messages .....

When messages contain character data that the receiver can decode while receiving in Digital Mode or Data Mode, it will automatically display it on the reception screen. No special operations are required. The display supports alphabetical letters, numbers, Japanese characters and symbols.

- Turn [Dial] to scroll back and forth through text.
- After being displayed, the receiver will return to the reception screen after 10 seconds of inactivity or by pressing any key.
- The message display time can be changed using "Message Display Time" (P.91) in the "Display" menu in Set Mode.
- As with AIS, the decoding rate will increase when battery save is turned off. Press [SET] key on the reception screen to turn off battery save in the "Power" menu in Set Mode. (P.95)

**REFERENCE**

The character display function can be set to not be used in Set Mode. If messages that were being received are no longer being displayed, check if the “Message Display Time” item (P.91) is set to “Do not display.”

**NOTE:**

Depending on the type of radio wave, messages may not be received.

**Example: Receiving ACARS**

Even though the digital VDL is taking over, ACARS is still an easier way to test the message receiving function of the receiver. Major ACARS frequencies are international 131.55, European 131.75, US 130.425 and Japan 131.45MHz with more sub channels.

1. Go outdoors or connect a commercially available external VHF antenna during the hours when aircraft are operating. Tune to your local ACARS channel in VFO Mode. Frequency info is easily available on the internet.
2. Press [MODE] key, operate [Dial] and [SET] key on the MODE screen to select “Data,” press [SET] key to select “ACARS,” and then press [SET] key to confirm.
3. When a characteristic, short burst noise is heard, it is ACARS. When a signal containing data is able to be received, characters will be displayed on the reception screen automatically.

Once the signal is confirmed, set the volume to zero to avoid listening noise-alike sounds. No need to open squelch to use AIS/ACARS modes of this receiver.

- Some larger airports use ACARS for on-ground clearance delivery communications.
- ACARS position-display software available from third-parties are not supported by the receiver's ACARS mode.
- In recent years, VHF Digital Link (VDL) systems have also been employed, and not all aircraft communicate via ACARS. The receiver cannot decode VDL.

The receiver will display characters when receiving signals contain messages like user names and callsigns while receiving audio signals also.

**● Message Log**

The last three messages received can be saved. When the power is turned off, the messages will be deleted. When the number of messages exceeds three, they will automatically be deleted in order of oldest to newest.

1. Press [SET] key on the reception screen to switch to Set Mode.
2. Turn [Dial] to select “Message Log,” and then press [SET] key.
3. Turn [Dial] to select the message number you wish to display, and then press [SET] key. To cancel, press [MONI] key or turn [Dial] to select “Back,” and then press [SET] key to return to the previous screen.
4. Press [MONI] key to exit the message log screen and return to the previous screen.



# 8



## Set Mode

Make the unit easier to use by changing various functions to suit your needs.

In Set mode, the following items can be customised.

White text indicates the Initial value.

### Set mode list

[Setting]	
[Display Mode] .....	<b>Basic Display</b> / Position Display / GPS Display
[Antenna] .....	<b>SMA Antenna</b> / Earphones
[Message Log]	
 [Message 1]	
 [Message 3]	
[Scan]	
[Scan Speed].....	<b>100ch/s</b> / 50ch/s / 25ch/s
[Hold Timer] .....	<b>OFF</b> / 1 Second/ 2 Seconds/ 3 Seconds/ 5 Seconds/ 10 Seconds/ 20 Seconds/ 30 Seconds/ 60 Seconds/ 90 Seconds/ <b>120 Seconds</b> / 180 Seconds
[Release Timer].....	OFF/ 1 Second/ 2 Seconds/ 3 Seconds/ <b>5 Seconds</b> / 10 Seconds/ 20 Seconds/ 30 Seconds/ 60 Seconds/ 90 Seconds/ 120 Seconds/ 180 Seconds
[Stop Freq].....	V FO/VFO(SCAN) / <b>SCAN</b>
[Manual Hold] .....	<b>OFF</b> / ON
[Priority Inter].....	OFF/ 1 Second/ 2 Seconds/ 3 Seconds/ 4 Seconds / <b>5 Seconds</b> / 10 Seconds/ 20 Seconds/ 25 Seconds/ 30 Seconds/ 35 Seconds/ 40 Seconds/ 45 Seconds/ 50 Seconds/ 55 Seconds/ 60 Seconds
[MHz Scan Width].....	0.25MHz / 0.5MHz / <b>1.0MHz</b> / 1.5MHz / 2.0MHz / 3.0MHz / 5.0MHz
[Freq Shift Scan] .....	<b>OFF</b> / ON
[MN Search] .....	<b>OFF</b> / ON
[VFO Scan] .....	<b>From Previous</b> / Scan Selection
[All Scan Set].....	<b>OFF</b> / ON
[Skip]	
[Program Link] .....	<b>Individual</b> / Common
[Bank] .....	<b>Individual</b> / Common
[Bank Link].....	<b>Individual</b> / Common
[Audio]	
[Beep].....	OFF / Volume Linked / Low/ <b>Medium</b> / High
[Vol Reduction] .....	<b>OFF</b> / Low/ Medium / High / Mute
[Removal Set ] .....	<b>Normal</b> / Mute
[Vol Stabilize].....	<b>OFF</b> / High Volume Suppression / Vol Assist Low Vol Assist High
[Bass Supp] .....	<b>OFF</b> / Weak / Medium / Strong
[Treble Supp].....	<b>OFF</b> / Weak / Medium / Strong

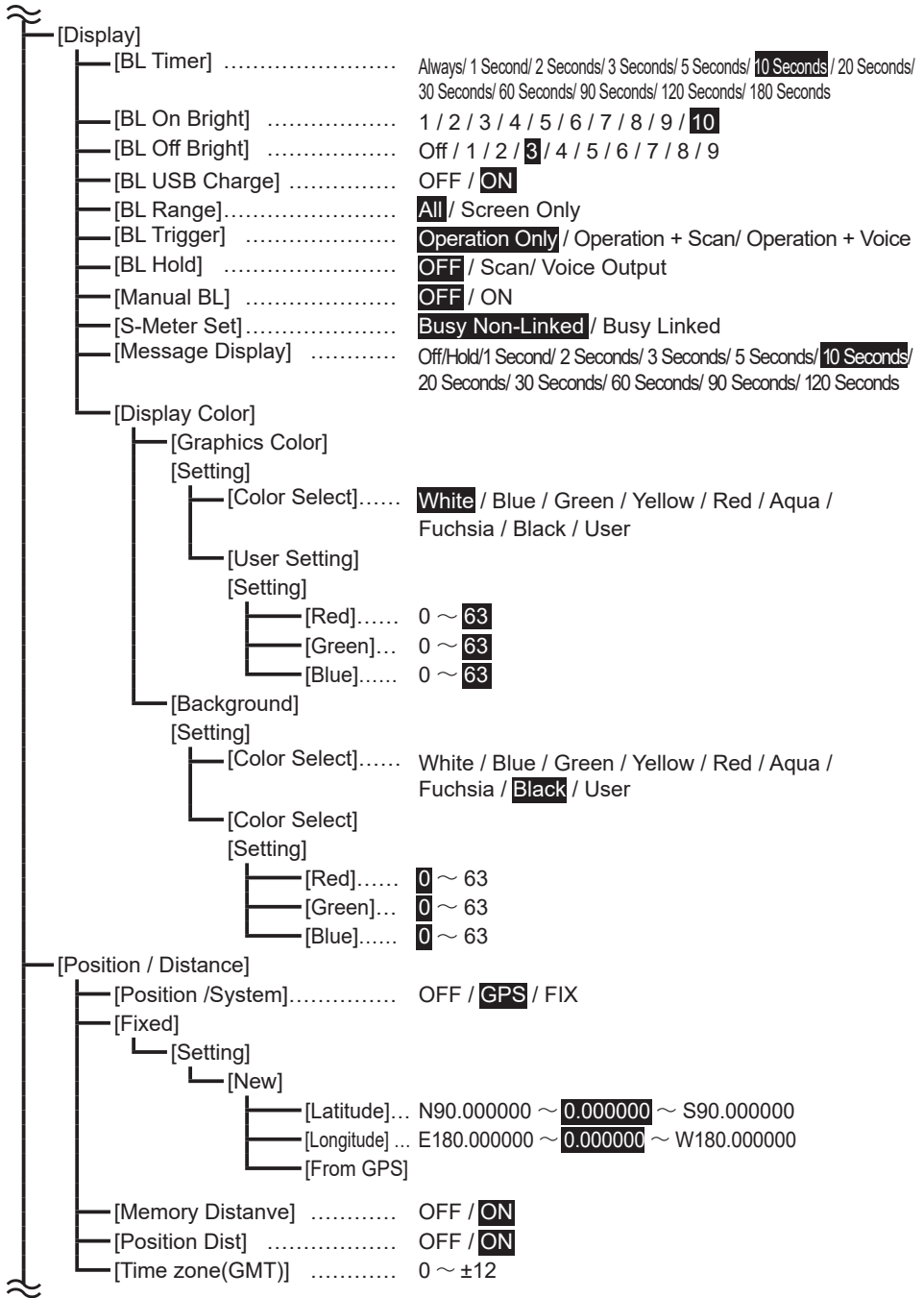

[Operation]	
[MONI Settings] .....	Alternate / <b>Momentary</b>
[Dial accerataoin.] .....	<b>OFF</b> / ON
[Dial] .....	<b>Selector</b> / Volume/Squelch
[Ring] .....	Selector / <b>Volume</b> / Squelch
[Vol/SqI Swap] .....	<b>OFF</b> / ON
[Dial Vol(Lock)] .....	<b>OFF</b> / ON
[QR (Lock)] .....	OFF / <b>ON</b>
[Key Lock Range].....	All / <b>Key+Selector</b> / Key / Selector
[FUNC Hold Time] .....	<b>5 Seconds</b> / 10 Seconds / 20 Seconds / 30 Seconds / Hold
[Power]	
[Battery Save] .....	<b>OFF</b> / ON
[Auto Power Off] .....	<b>OFF</b> / 10 Minutes / 20 Minutes / 30 Minutes / 1 Hour / 2 Hours / 3 Hours / 5 Hours
[USB Power Supply] .....	OFF / <b>ON</b>
[USB Charge] .....	OFF / <b>ON</b>
[Adjustment]	
[S-Meter] .....	-10 ~ <b>0</b> ~ +10
[Standard Freq].....	-100 ~ <b>0</b> ~ +100
[Status]	
[Power Status]	
[Device Info]	

## ..... How to set Setting Mode .....

This is an operation that has already been explained so far.

- 1 Press [SET] key on the receiving screen to enter set mode, and "SETTING" will be displayed in the upper left.
- 2 Turn [Dial] to select the item you want to set, and press [SET] key.
- 3 When the item you want to set is open, turn [Dial] to select the setting value, and press [SET] key.



### REFERENCE

In the menu selection screen of the set mode, the "2", "6", "8", and "4" keys function like a cross key.

You can move the cursor and select items more quickly than by turning the dial.

### ■ Display mode

Change the receiving screen.

Options: Basic display / Position display / GPS display

Default: Basic display

## ■ Antenna

Switches between the earphone antenna and the external antenna(SMA port). When earphones are selected, the earphone cord becomes a simple antenna, allowing signals to be received without antenna connected to SMA port. Please use 3.5Φ stereo earphones for antenna purposes. Due to the circuit configuration of monaural earphones, the received signal is attenuated. Monaural eraphones are usable normally if not used as an antenna.

Earphones: The earphones are used as an antenna.

Selection items: SMA Antenna, Earphones

Initial value: SMA antenna



### REFERENCE

- The earphone antenna reception status may change or become unstable depending on the length and condition of the cord (e.g., bent, the direction that the user is facing, curled, etc.).
- The earphone antenna is not an antenna tuned to a frequency. It is designed to discreetly receive strong radio waves, such as FM broadcasting or air bands received at airports, by removing the whip antenna.

## ■ Message Log

The text information for the selected message number is displayed using the message display screen. (P.80)

When there is no message, the number will not be displayed.

Selection items: Message 1 to message 3

Initial value: - (no message)

## ■ Scan

### ● Scan Speed

This setting changes the scanning speed.

100 ch/s is the fastest scan, but it may not stop if a signal is weak.

Selection items: 100 ch/s / 50 ch/s / 25 ch/s

Initial value: 100 ch/s

### ● Hold Timer

This is the amount of time to receive signals when the scan has stopped. Scanning resumes after the designated amount of time has elapsed. OFF is a busy scan. After scanning has stopped, reception continues until there are no more received signals. The scan will remain stopped when there are signals with constant radio wave emission, such as ATIS broadcasting at airports.

Selection items: OFF/1 sec./2 sec./3 sec./5 sec./10 sec./20 sec./30 sec./60 sec./90 sec./120 sec./180 sec.

Initial value: OFF

**● Release Timer**

Set the amount of time to wait before resuming scanning when there are no more received signals after scanning has stopped.

OFF will not resume until the dialing operations are performed.

Selection items: OFF/1 sec./2 sec./3 sec./5 sec./10 sec./20 sec./30 sec./60 sec./90 sec./  
120 sec./180 sec.

Initial value: 5 sec.

**● Stop Freq(Frequency)**

This is the setting for which frequency to return to when scanning is stopped for a Program Scan and Program Link Scan.

Selection items:

VFO: VFO frequency before starting a scan

VFO (SCAN): Frequency stopped by the scan when the VFO frequency before starting the scan is within scan range; it is otherwise the VFO frequency before the scan starts

SCAN: Frequency stopped by scan

Initial value: VFO

Example 1: While receiving at 145.000 MHz, a Program Scan from 144.000 MHz to 146.000 MHz will start and then stop at 145.500 MHz. VFO to return to 145.000, VFO (SCAN) or SCAN to return to 145.500

Example 2: While receiving at 145.000 MHz, a Program Scan from 430.000 MHz to 440.000 MHz will start and then stop at 433.500 MHz. VFO or VFO (SCAN) to return to 145.000, SCAN to return to 433.500

**● Manual Hold**

The resumption of scanning can be paused by operating the dial. This is useful when it is difficult to operate the keys, such as when the receiver is placed in a pocket.

OFF: When the dial is turned one click while scanning, it will scan in the direction of the turn (ascending or descending order). Dialing does not stop scanning.

ON: Turn the dial one click to pause, regardless of the scan resume setting. Turn it one more click to resume scanning in the direction turned. when scanning is not stopped with the dial, it stops and resumes under designated conditions.

Selection items: OFF/ON

Initial value: OFF

**● Priority Interval**

Set the interval at which priority channels are received during a Priority Scan.

Selection items: 1 sec./2 sec./3 sec./4 sec./5 sec./10 sec./15 sec./ 20 sec./25 sec./30 sec./  
35 sec./40 sec./45 sec./50 sec./55 sec./60 sec.

Initial value: 5 sec.

● **MHz Scan Width**

Set the MHz Scan range.

Selection items: 0.25/0.5/1.0/1.5/2.0/3.0/5.0MHz

Initial value: 1.0 MHz

● **Freq(Frequency) Shift Scan**

Allow the choice of whether or not the shifted side of the frequency set in the shift frequency during a VFO Scan or Memory Scan is also subject to the scan.

OFF: It is not subject to the scan.

ON: It is subject to the scan.

Selection items: OFF/ON

Initial value: OFF

● **MN(Memory Name) Search**

Checks if the frequency stopped by the VFO Scan is registered in the memory.

When the frequency stopped by the VFO Scan is registered in the memory and the memory name is also registered, that memory name will be displayed.

When there are multiple registrations for the same frequency, the memory name of the smallest memory number will be displayed.

Selecting ON does not change the accuracy or speed of the scan.

OFF: This does not check.

ON: This checks.

Selection items: OFF/ON

Initial value: OFF

● **VFO Scan**

Set the operation when [SCAN] key is pressed in VFO Mode.

From previous scan: This runs the same scan mode as the previous scan.

Scan Selection: This displays the scan type selection screen. (This is the same operation as holding down [SCAN] key).

Selection items: From previous scan/Scan selection

Initial value: From previous scan

● **All Scan Set**

Hold down [SCAN] key to select the item to be displayed on the scan type selection screen.

OFF: This displays only the scan type corresponding to the Receive Mode in use.

ON: This displays the scan type in both VFO Mode and Memory Mode.

Selection items: OFF/ON

Initial value: OFF

## ■ Skip

### ● Program Link

Allow the choice of whether or not to use the individual Program Scan skip designation for a Program Link Scan.

Individual: Skips are newly designated and used exclusively for Program Link Scans.

Skips designated at this time are not reflected in individual Program Scans.

Common: The skip designated for each Program Scan is also used for linking.

Selection items: Individual/Common

Initial value: Individual

### ● Bank

Allows the choice of whether or not to use the skip for an All Memory Scan during a Bank Scan.

Individual: Skips are newly designated and used exclusively for Bank Scans.

Skips designated at this time are not reflected in All Memory Scans.

Common: All Memory Scan skips are also used for Bank Scans.

Selection items: Individual/Common

Initial value: Individual

### ● Bank Link

Allows the choice of whether or not to use the skip for a Bank Scan during a Bank Link Scan.

Individual: Skips are newly set and used exclusively for Bank Link Scans.

Common: Bank scan skips are also used for Bank Link Scans.

Selection items: Individual/Common

Initial value: Individual

## ■ Audio

### ● Beeping Sound

This is the volume setting for the beeps that sound during operation. The volume linkage also makes the beeping sound louder when the volume is increased. There will not be a beeping sound when OFF.

Selection items: OFF/Volume Linked/Low/Medium/High

Initial value: Medium

### ● Vol(Volume) Reduction

This is an operation setting when communications are received in FM Radio Mode.

Once the communication signal is lost, the FM radio volume will return to normal after approximately 3 seconds.

OFF: The FM radio volume remains the same.

Low: This reduces the FM radio volume to approximately 60%.

Medium: This reduces the FM radio volume to approximately 40%.

High: This reduces the FM radio volume to approximately 20%.

Mute: This sets the FM radio volume to zero (mute).

Selection items: OFF/Low/Medium/High/Mute

Initial value: OFF

### ● Removal Setting

This function prevents the speaker from emitting sound when the earphones are unplugged. This prevents such mishaps as unplugging the earphones by mistake in public spaces and having the received audio become audible.

Normal: The volume remains the same, and sound emits from the speaker.

Mute: The speaker volume is set to 0 (mute), and “Earphones are unplugged” will be displayed.

When the earphones are plugged in, it will be restored to normal. When the dial is turned or any key operation is performed while the earphones are unplugged, the speaker will emit sound, and the volume and screen will switch to those of the normal reception screen.

Selection items: Normal/Mute

Initial value: Normal

### ● Vol(Volume) Stabilization

This function makes the audio easier to hear by stabilizing the output of the received audio in Digital Mode.

OFF: This does not stabilize.

High volume suppression: This suppresses only high-volume sounds.

Volume assist low: This amplifies the audio slightly and suppresses high-volume sounds.

Volume assist high: This amplifies audio strongly and suppresses high-volume sounds.

Selection items: OFF/High volume suppression/Volume assist low/Volume assist high

Initial value: OFF

### ● Bass Supp(Suppression)

This function suppresses the low frequencies of received audio. Set as desired.

This runs in both analog and digital.

OFF: This does not suppress.

Selection items: OFF/Weak/Medium/Strong

Initial value: OFF

### ● Treble Supp(Suppression)

This function suppresses the high frequencies of received audio. Set as desired.

This runs in both analog and digital.

OFF: This function is disabled.

Selection items: OFF/Weak/Medium/Strong

Initial value: OFF



## ■ Display

### ● BL(Backlight) Timer

The LCD screen automatically dims slightly after a certain amount of time without operation. This designates the amount of time without operation until the LCD and keyboard backlight dims.

Selection items: Always/1 sec./2 sec./3 sec./5 sec./10 sec./20 sec./30 sec./60 sec./90 sec./120 sec.

Initial value: 10 sec.

The shorter the set value, the less battery it will consume; the always-on light consumes the most battery power. The battery will be depleted in about 9 hours simply in Standby Mode with the always-on light.



### REFERENCE

Regardless of the settings in this section, the always-on light can also be turned on by the Set Mode operations described below.

- The “Backlight (Power from USB)” function allows the light to turn on only when connected to a USB port.
- The “Manual Backlight” can be turned on and off manually. The light remains on unless it is turned off.

### ● BL(Backlight) On Bright

This sets the brightness of the LCD screen backlight during operation.

Selection items: 1/2/3/4/5/6/7/8/9/10

Initial value: 10

The lower the number, the darker it will be. Select a value and press [SET] key to reflect your desired brightness. The darker it is, the better the battery life will be.

### ● BL(Backlight) Off Bright

This sets the brightness of the LCD screen backlight when not in operation.

Selection items: Light off/1/2/3/4/5/6/7/8/9

Initial value: 3

The lower the number, the darker it will be. Select a value and press [SET] key to reflect your desired brightness. The darker it is, the better the battery life will be. Select light off to remove the display. It will return to the display brightness (backlight on) when any operations are performed.

### ● BL(Backlight) USB Charge

The backlight can be automatically set to the always-on light only when power is supplied via USB connection.

OFF: This runs in the same way as during battery operation.

ON: This switches to the always-on light.

Selection items: OFF/ON

Initial value: ON

● **BL(Backlight) Range**

This allows for the choice of the range in which the backlight is lit up.

All: This turns on both the LCD screen and the keyboard backlight.

Screen only: This turns on the LCD screen backlight only.

Selection items: All/Screen Only

Initial value: All

● **BL(Backlight) Trigger**

The conditions for lighting up the backlight can be selected.

Operation Only: This turns the light on only when some kind of key or dial operation has been performed.

Operation + Scan: This turns the light on during any operation and when scanning is stopped.

Operation + Audio Output: This turns the light on during any operation and audio output.

Selection items: Operation Only/Operation + Scan/Operation + Audio Output

Initial value: Operation Only

● **BL(Backlight) Hold**

The backlight timer operation can be temporarily extended.

OFF: There is no extension. Only the operation designated for the "Backlight Timer" item is performed.

Scanning: The backlight turns on until scanning stops and resumes.

Audio Output: This backlight turns on until there is no audio output from the speaker or earphones.

Selection items: OFF/Scan/Voice Output

Initial value: OFF

● **Manual BL(Backlight)**

The backlight can be manually set to the always-on light or turned off.

OFF: The backlight is not operated by button operation.

ON: The backlight is operated by button operation.

Selection items: OFF/ON

Initial value: OFF

Press [FUNC] key to light up <FUNC> on the display, and then press [FUNC] key to produce a beeping sound and turn on the backlight. The same operation will produce a beeping sound and return to the settings of the backlight timer, etc. The backlight will remain on until it is turned off.

The ● icon will be displayed below the frequency step while the manual light is on.

● **S-Meter Set**

The S-meter Setting can be selected. This is common to all Receive Modes.

Busy not linked: The S-meter always display segments when there seems to be an RF signal, including noises. Pressing [MONI] key only opens the squelch and does not change the S-meter display.

Busy linked: The BUSY icon and S-meter will be displayed when there is an RF signal that has been determined to not be noise. Press [MONI] key to open the squelch, and the BUSY icon and S-meter will blink. In either case, when the squelch is 0, "BUSY" will be displayed regardless of whether RF signals are present.

Selection items: Busy Non-Linked/Busy Linked

Initial value: Busy Non-Linked

### ● Message Display

This is the amount of time before returning from the message displayed on the LCD to the original screen. This is the amount of time before returning from the message to the original screen. When no operation is performed within the designated amount of time, it will automatically return to the original screen.

When a new message is received within the designated amount of time, the newer one will be displayed regardless of the designated amount of time.

No display: No message will be displayed even if received.

Hold: This does not return to the original screen until an operation is performed. New messages will be displayed when received.

Selection items: No display/Hold/1 sec./2 sec./3 sec./5 sec./10 sec./20 sec./30 sec./60 sec./90 sec./120 sec.

Initial value: 10 sec.

### ● Display Color

This sets the letters and graphics as well as the background.

Select "Settings" and press [SET] key to display the "Letters and Graphics" and "Background" selection item screen.



#### REFERENCE

Perform the following operations if the background and characters have unintentionally been set to similar colors, making it difficult to see the characters:

- Turn off the receiver's power, and then turn it on while holding down [FUNC] and [MODE] keys. When the startup screen is displayed and there is a beeping sound, release your finger. The letters and background color are initialized to black and white. No other settings will be affected in any way. The exact same color produces a warning message, and it cannot be selected.

### Letters and graphics

Press [SET] key in "Settings" to select the "Color Selection" and "User Setting."

#### Color Selection

Turn the dial to select the character color on the LCD screen. Select a color and press [SET] key to see the reflected status. When "User" is selected, the color will be the customized color of the entered RGB values in the User Setting menu below. When the same color as the background is selected, there will be a warning that "The color is the same as the background color," and it cannot be selected.

Selection items: White/Blue/Green/Yellow/Red/Aqua/Fuchsia/Black/User

Initial value: White

## User Setting

The letters and graphics can be set from a combination of RGB (The three primary colors of Red, Green, and Blue).

Select "Settings" for the User Setting, and then press [SET] key to display the "Red," "Green," and "Blue" selection item screen. Select the color set value you wish to change, and then press [SET] key.

Turn the dial or enter a numerical value to change the value. Press [STEP] key to return to the initial value. After making changes, press [SET] key to have the settings reflected and return to the previous selection screen.



### REFERENCE

Search on the internet for such keywords as "Color Code RGB" and refer to a list of color samples and RGB numerical values.

#### Red

This changes the intensity of the redness of the characters.

Numerical value range: 0 to 63

Initial value: 63

#### Green

This changes the intensity of the greenness of the characters.

Numerical value range: 0 to 63

Initial value: 63

#### Blue

This changes the intensity of the blueness of the characters.

Numerical value range: 0 to 63

Initial value: 63

## Background

Press [SET] key in "Settings" to select the "Color Selection" and "User Setting."

The operations are the same as for the letters and graphics.

## Color Selection

The background color of the LCD screen can be changed.

When "User" is selected, the color will be the color set in User Setting.

Selection items: White/Blue/Green/Yellow/Red/Aqua/Fuchsia/Black/User

Initial value: Black

## User Setting

The background can be set from a combination of RGB (The three primary colors of Red, Green, and Blue).

Select "Settings," and then press [SET] key to display the "Red," "Green," and "Blue" selection item screen.

The selection items are the same as for "Letters and Graphics."

Initial value: 0

## ■ Position/Distance

### ● Position System

This is the reference setting for the longitude and latitude used for the distance and position display.

OFF: This does not use position-related functions. The entered FIX position information is also not used.

GPS: This turns on GPS and uses the position information received from satellites.

FIX: This uses the pre-entered longitude and latitude as position information.

Selection items: OFF/GPS/FIX

Initial value: GPS

#### NOTE:

Turning on GPS consumes battery power. During battery operation, it is recommended to frequently turn off the GPS function when it is not needed or to use FIX.

### ● Fixed Lon(Longitude) Lat(Latitude)

The longitude and latitude can be set for when "FIX" is selected in the position system setting.

This enters the longitude and latitude in DEG (Degree) format (decimal values).

The current longitude and latitude can be set as the fixed longitude and latitude using GPS. For how to register, read the longitude and latitude section within Registering Memory Channels (P.53).

Latitude = N/S 00.000000 to 90.000000

Longitude = E/W 000.000000 to 180.000000

Initial value: Unregistered

### ● Memory Dist(Distance)

When receiving in Memory Mode, the distance between two points can be displayed by analyzing the longitude and latitude information registered in the memory channel and the GPS or FIX position information. The distance that can be displayed is from 0.01 km to 999.99 km.

OFF: Do not display.

ON: Display.

Selection items: OFF/ON

Initial value: ON

### ● Position Dist(Distance)

When a signal with position information is received, such as with AIS, the distance and azimuth between two points can be displayed by analyzing the position information and the GPS or FIX position information. The distance that can be displayed is the same as the memory distance setting.

OFF: Do not display the position information.

ON: Display.

Selection items: OFF/ON

Initial value: ON

● **Time zone**

The time information of GPS receiver can be displayed to suit your local time. UTC is coordinated Universal Time, Please care about the daylight time (summer time) that requires manual correction.

Selection Items: 0~±12 (E.g. UTC New York is -5, Paris +1, Tokyo +9 and Sydney +11)

Initial value: 0 (UTC)

\* Apologize for not being compatible to time zones of 15/30/45min.

■ **Operations**

● **MONI Setting**

This is an operation when [MONI] key is pressed.

Alternate: Once [MONI] key is pressed, it will maintain the monitor status until it is pressed again.

Momentary: Monitoring will be available only while [MONI] key is pressed.

Selection items: Alternate/Momentary

Initial value: Momentary

● **Selector Acceleration**

The dial used to switch frequencies and Set Mode items is called the selector, and its initial setting is for [Dial]. The width changed depends on the strength with which the selector is turned. This function greatly changes the frequency, Set Mode item, etc. when turned.

OFF: Change by only the number of clicks turned.

ON: Change more than the number of clicks turned. Turn one click to perform normal operations.

Selection items: OFF/ON

Initial value: OFF

● **Dial**

The functions of [Dial] can be changed.

Selection items: Selector/Volume/Squelch

Initial value: Selector

● **Ring**

The functions of [Ring] can be changed.

Selection items: Selector/Volume/Squelch

Initial value: Volume

● **Vol(Volume)/Sql(Squelch) Swap**

The initial setting only allows the volume to be adjusted by turning the dial designated for volume control. When this function is turned on, it will adjust the volume when not in FUNC status, and it will adjust the squelch level when [FUNC] key is pressed and FUNC is lit up.

OFF: This is the initial setting operation.

ON: The squelch level can also be adjusted while FUNC is displayed.

Selection items: OFF/ON

Initial value: OFF

**● Dial Vol(Volume) (Lock)**

This function allows a selector that is no longer used after key lock to be used instead of the volume control volume only while locked.

OFF: This keeps the selector locked.

ON: The volume is operated by the selector.

Selection items: OFF/ON

Initial value: OFF

**● QR(Quick Recall) (Lock)**

This setting determines whether Quick Recall (recall operation) is used during key lock.

OFF: This allows quick recall.

ON: This blocks quick recall operations in the key lock status.

Selection items: OFF/ON

Initial value: ON

**● Key Lock Range**

The key or dial to apply the key lock can be designated.

[FUNC] and [POWER] keys can be operated to unlock the keypad even when in key lock.

All: Lock all operations.

Key + Selector: This locks the dialing operations set for the keyboard and selector.

Key: This locks keyboard operations.

Selector: This locks the dialing operations set for the selector.

Selection items: All/Key + Selector/Key/Selector

Initial value: Key + Selector

**● FUNC Hold Time**

Press [FUNC] key to select the amount of time to hold the <FUNC> status. The amount of time from when the FUNC icon turns on until it turns off. "Hold" is recommended while you are still unfamiliar with the operations.

Hold: This holds the FUNC status until the next operation.

Selection range: 5 sec./10 sec./20 sec./30 sec./Hold

Initial value: 5 sec.

**■ Power****● Battery Save (BS)**

This function reduces power consumption during standby and prolongs battery life by powering on and off at short intervals within the receiver's circuitry. Turning on BS for digital or data communications will make reception and decoding more difficult.

Selection items: OFF/ON

Initial value: OFF

**NOTE:**

- When BS is turned on, BAT SAVE will be displayed on the device information screen. (P.99)
- The initial value of the receiver for BS is OFF as it may result in poor data decoding rates or failure to demodulate digital audio. Even for receiving analog signals, the audio may sound choppy when BS is running. The off setting is recommended when USB power is available, but when using a battery pack, turning on BS is recommended in Analog Mode. It is convenient to register the battery save toggle screen in quick recall.
- In principle, battery save is not possible when the squelch is open during signal reception, scanning, or monitoring. Five seconds after the end of such a status, BS resumes operating. The receiver's BS ratio is 0.2 when ON to 0.8 when OFF (seconds).

**● Auto Power Off**

When there are no operations for a designated amount of time, there will be a beeping sound and the power will automatically turn off. The initial value is OFF, and the APO icon lights up when the time is set.

Press the power switch to restart. When a key or dial is operated within the amount of time on the timer, the counter is reset and it begins to recount from there. The timer does not stop with changes in reception conditions, such as whether there is a received signal or scan.

Selection items: OFF/10 minutes/20 minutes/30 minutes/1 hour/2 hours/3 hours/5 hours

Initial value: OFF

**● USB Pow(Power) Supply****● USB Charge**

Selection items: OFF/ON

Initial values: ON

\* BE SURE TO SET BACK ON to return to basic charging method.

These are how to manage battery charge and operation current of the receiver.

- To prevent charging battery of the receiver from a laptop PC battery while using DJ-X100 software via USB cable, select OFF of [USB Pow(Power) Supply]. USB communication port is always active regardless of this setting.
- To prevent from overcharging the battery, select OFF of [USB Charge]. This allows to supply current to the receiver only, not to the charging circuit. This is also recommended to those who use optional charging stand only to charge the battery. It is ideal that the battery be charged alone using optional charging stand.

**NOTE:**

When "USB Power Supply" is set OFF, follow the instructions below otherwise it may cause the receiver to not start up properly.

- 1: Connect a battery pack or a dry-cell battery case to start up the receiver before connecting a USB cable.
- 2: Unplug the USB cable first before turning off the receiver's power.

When "USB Charge" is turned OFF, it may seem that the external device's battery would not be depleted since it is not charged by the current from the USB. However, the current to power the receiver is still supplied by the external device's battery in this condition. Turning OFF [USB power supply] conserve most of the battery in external devices.



**Important**

When the receiver can not start up due to misoperation of USB supply/charge parameters, Plug in the USB cable to supply DC current to the receiver while pressing and holding <FUNC> and <SCAN> keys together.

**■ Adjustments****● S-Meter**

The lit up segments of the S-meter can be changed based on the number of segments when the set value is 0.

For example, if three segments are lit up when the set value is 0, four segments will be lit up when the set value is set to +1.

Numerical value range: -10 to +10

Initial value: 0

The receiver's S-meter does not display the electric field strength as accurately as a measuring instrument would, and the S-meter indications may vary depending on receivers, even a same signal is received at the same place. In case the receiver's indication level is inaccurate comparing to other receivers, use this feature to correct the indication level.

**● Standard Freq(Frequency)**

The "Standard Frequency" is originally adjusted using a measuring instrument in the factory, but since the receiver uses Digital Mode, in which the slightest shift in frequency will result in loss of reception, this basic frequency can be adjusted in a simple manner.

Resetting will return to the status before the change, but moving the set value greatly will cause it to be unable to receive properly.

Numerical value range: -100 to +100

Initial value: 0

**REFERENCE**

This function was adopted with correcting frequency shifts that occur over time in mind. Do not make adjustments without reason. The frequency display does not change.

This number does not have such a unit as hertz and is a parameter for the programs.

Adjust for optimum reception while actually receiving.

## ■ Status

This displays the status and information of the receiver on the LCD.

### ● Power Status

A screen will be displayed for checking the power supply status. It is divided into left and right.

#### Current Route

The left side of the screen shows the power supply information in use.

The USB icon indicates USB power supply, and the icon will be marked with an X when the USB cable is unplugged. BAT is the battery, and both the dry-cell battery case and battery pack are indicated by BAT. The ▲ arrow indicates the direction of the current.

$I \leq 1.5A$ : This will be displayed when the current that can be supplied from the USB is between 0.5A and 1.5A.

$I \leq 0.5A$ : This will be displayed when the current that can be supplied from the USB is 0.5A or less. (This will be displayed when something like the USB Type-A port on a PC is used.)

BC1.2: This will be displayed when the current that can be supplied is determined from the BC1.2 specification (Battery Charging specification 1.2). Nothing will be displayed for normal Type-C USB power supply.

The upper right illustration shows that the current is flowing from a USB device to the receiver and battery pack. The lightning bolt icon indicates that the battery is charging, and the X icon is displayed for channels without a current. The RPD CHG section in the lower left corner will display the following:

USB OFF : When the battery pack or dry-cell battery case is being used

BAT OFF : During USB power supply

RPD CHG : The USB power supply is 1.5A or less, and the battery pack is being charged rapidly

NRM CHG : The USB power supply is 0.5A or less, and the battery pack is being charged

CHG CMP : When the battery is fully charged and charging is completed

!! COLD : When charging is not possible due to low temperatures

!! HOT : When charging is not possible due to high temperatures

!! TOT : When the charge timer is operating with USB charge and stops charging

CHG ERR : Other times when charging is not possible

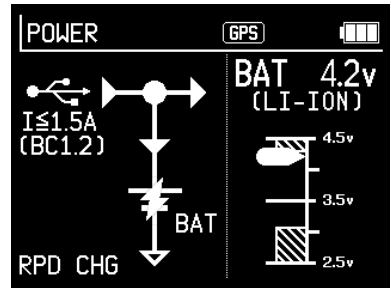

#### REFERENCE

NRM CHG will be displayed when the power is supplied from the USB Type-A port of the PC.  
 USB OFF will be displayed when the USB is disconnected.

#### Battery Voltage

The right side of the screen displays the battery voltage and type.

LI-ION: battery pack

DRY-CELL: dry-cell battery case

When the batteries are removed, an X will be displayed in the voltage graph, and --V will be displayed for BAT.

### ● Device Infor(Information)

Turn off the power, and then turn it on while holding down [MONI] key to display the software version, memory usage, settings, etc. Operate any key to switch to the reception screen.

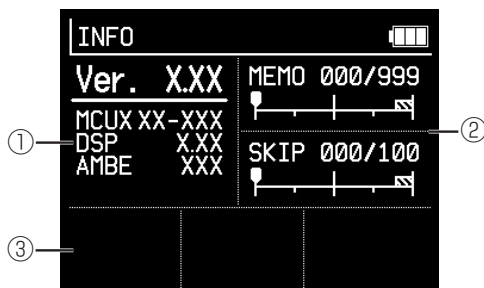

①	<p>This is information on the receiver's programs and important devices.</p> <p>Ver. : Version            MCU : CPU Version            DSP : DSP Version            AMBE : AMBE Release Number</p> <p>Note: The Ver, MCU, and DSP numbers may change when there are some changes to the receiver's programs, but the numbers may also change for reasons completely unrelated to function or performance, for example, changes to the automatic adjustment programs during production, etc. If there are any function additions or bug fixes, we will release that information on our website. Differences in numbers in the absence of such a notice are administrative changes. We will not disclose any details of administrative changes even if inquired.</p>
②	<p>This displays on a graph the current number used and the maximum number available.</p> <p>MEMO : Number of memory channel registrations            SKIP : Skip usage</p>
③	<p>ANT EAR : Earphone antenna selected            GPS OFF : Position system setting is "OFF"            POS FIX : Position system setting is "FIX"            REF ADJ : Basic value is set to something other than 0 in the standard frequency setting            SMT ADJ : Basic value is set to something other than 0 in the S-meter setting            REF SMT : Basic value is set to something other than 0 in both the standard frequency and S-meter settings            KLC KEY : Key lock range setting is "Key"            KLC DAL : Key lock range setting is "Selector"            UDL VOL : Dial setting is "Volume"            UDL SQL : Dial setting is "Squelch"            LDL SEL : Ring setting is "Selector"            LDL SQL : Ring setting is "Squelch"            BAT SAVE : Battery save is "ON"</p>

# 9

## PC Connection

The DJ-X100 has two types of software: utility software for editing memory channels as well as saving and loading their data files, and geolocation software for displaying received characters and position information on a digital map on line.

Search for the DJ-X100 software download at [alinco.com](http://alinco.com)

The receiver can be connected to a computer with the supplied USB cable. There is no need for optional PC cables. Software runs on operating systems Windows 10 or later. No driver software installation is required as the PC will recognize the receiver as a USB device.

To connect to third-party receiver software, read the instructions for that software. Alinco cannot provide any support for consultations with regard to connecting third-party software.

[Requests regarding the use of the software/Please read carefully]

Software for DJ-X100 is provided free of charge as a service.

The receiver can be used without the use of software, and the software was not developed with the intention of it being used by all users. For this reason, we do not provide individualized support for computer and software operations. In addition to such basic computer operations as software installation, the user should have enough knowledge to be able to view the OS device manager, save and recall edited data, and understand the functions employed in the receiver.

Note that this is free software, and we cannot compensate for any damage to hardware, other software, or data that may result from using the software. In the rare case that the product does not run properly due to compatibility issues with your computer, we cannot guarantee that we will be able to provide individualized support. Software updates will end if the product is discontinued. Note that there is the possibility that a newly provided OS may not be compatible.

Although Alinco Incorporated owns the copyright on the software, it is free to use as long as it is not used for commercial purposes.

Use the software only if you agree to the above.

Instructions for operating the software are included with the software to download or are available on the same download page.

# 10

## Reset

This unit has three types of reset (initialization).

### Reset(Only display)

Use this reset when the screen is difficult to see due to an incorrect display color setting.

- 1 Turn the unit off.
- 2 Turn the power on while pressing and holding [FUNC] key and [MODE] key together.
- 3 Release the keys when the startup screen appears.
- 4 A “beep beep” will sound and the unit will start up with the default display settings of white text on a black background.

No settings other than the display color are affected.

### Reset(Partially)

Use this when you don't know how to operate the unit or when it is not working properly.

The memory channel data and associated scan information will remain, but other settings will return to the factory settings.

- 1 Turn off the unit.
- 2 Turn the unit on while pressing [FUNC] key.
- 3 Release the key when the “ALINCO DJ-X100” startup screen appears.
- 4 The RESET screen shown in the illustration will be displayed, so use [Dial] to select “Yes” and press [SET] key to initialize and start up.

If you select “No” and press [SET] key or press [MONI] key, it will cancel and start up as is.

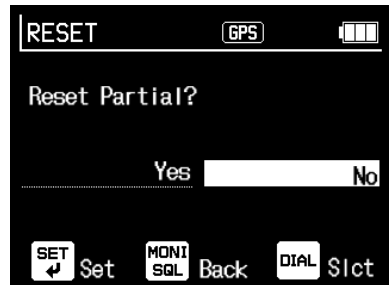

## Reset(All)

This reset initializes all functions and deletes all memory data, returning the unit to the factory settings.

If you want to keep the memory data, select Partial Reset. This unit does not have a backup or restore function. Please use the utility software distributed on our website.

- 1 Turn off the unit.
- 2 Turn on the unit while pressing [FUNC] and [MONI] keys together.
- 3 Release the keys when the "ALINCO DJ-X100" startup screen appears.
- 4 The RESET screen shown in the illustration will be displayed. Use [Dial] to select "Yes" and press [SET] key to initialize and start up.

If you select "No" and press [SET] key or [MONI] key, the reset will be canceled and the unit will start up as is.

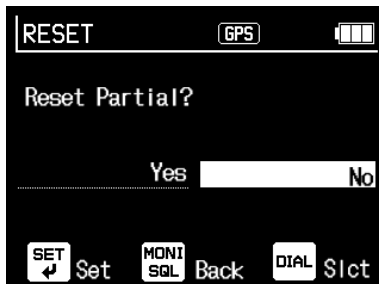

# 11

## Option List

- Charging stand set (EDC-325T): A set of a quick charging stand and an AC adapter.
- Soft case (ESC-65): Can be used with the belt clip attached.
- Battery case (EDH-46): Uses three AA alkaline batteries.

### About the EDH-46 battery case

- This battery case is for AA alkaline batteries only. Do not use manganese batteries or AA rechargeable batteries. This may cause malfunction. Replacing with the wrong type of battery may cause overheating or explosion.
- Never use third-party battery packs, drycell batteries, or rechargeable batteries made of Lithium materials as they may cause malfunction. Damage is not covered by the product warranty.
- Be careful not to reverse the +/- direction of the batteries. This may cause leakage, fire, or explosion.
- Use new batteries of the same type and manufacturer. When replacing the batteries, replace all batteries with the same new ones. Using different batteries may cause leakage, heat generation, etc.
- Clean the electrodes that come into contact with the batteries from time to time with a clean, dry cloth or cotton swab. Invisible dirt may cause poor contact.
- Use of EDH-46 voids waterproof warranty as it is not shielded like battery packs.

# 12

## Maintenance

### ..... Trouble Shooting Guide .....

The following symptoms may not be a malfunction. Please try the procedure described in “Troubleshooting.” If the problem persists after trying the procedure, try “partial reset” on P.101.

Problem	Cause	Corrective Action
When I turn it on, nothing shows on the display.	The battery is having a poor connection	Clean the battery and the battery terminals on the back of the unit with a dry, clean cotton swab, etc.
	The battery may be exhausting.	Recharge or replace the battery.
	[POWER] key released too soon	Press and hold [POWER] key firmly until turns on
No sound from the speakers.	Low Volume	Check level and increase volume
	High squelch level	Adjust the squelch level to an appropriate level
	Tone squelch, DCS, and codes are not matched	Press [MONI] key to see if it can be received.
The display screen is abnormal	The CPU is malfunctioning	Remove all source of DC power like USB and battery, and wait for 10 seconds or more to discharge internal electricity. Pressing and holding FUNC key, then connect USB to power on to perform partial reset.
Scan not working	Squelch is opened	Set squelch to disappear noise
Dial and key operations do not work	Keylock is active	Unlock
The display flashes or goes out during reception	The battery may be exhausting.	Recharge or replace the battery.



# 13

## Technical Specifications

Receive frequency range	Receive frequency range 30MHz ~ 470MHz 76.000000 ~ 108.000000MHz (WFM Only)
Frequency step	1/3.125/5/6.25/8.33/10/12.5/15/20/25/30/50/100/125/ 200kHz
Receiving mode	Analog: FM/NFM/AM/NAM/WFM Digital: DCR/DMR/NXDN/dPMR/D-STAR/C4FM(DN) Data: AIS/ACARS/12kIF(W)/12kIF(N)
Operating voltage	Li-ion battery 3.6V (EBP-114A, 3120mAh) Dry cell battery (optional parts) External power supply (USB Type-C) 5V
Current consumption	Standby: Approx. 150mA (BS ON, backlight, FM mode, GPS OFF) Standby: Approx. 300mA (Backlight/WFM mode OFF, GPS ON) When receiving: Approx. 500mA (FM rated output, backlight/WFM mode OFF, GPS ON)
Operation temperature	Reception: -20°C to +60°C Charging: +10 to +40°C
Dimensions	Width 58 x height 110 x depth 32.5mm (exclude antenna)
Weight	Approx. 260g (including antenna and accessory battery pack EBP-114A) Belt clip: Approx. 14g

Receiving	<p>[FM/AM/Digital/Data] Triple Super Heterodyne Conversion          1st IF : 243.95MHz.          2nd IF: 50.85MHz          3rd IF 450kHz</p> <p>[WFM] Direct Conversion</p> <p>Sensitivity: FM / NFM: <math>\leq -10\text{dB}\mu\text{V}</math> (12dB SINAD)          AM / NAM: <math>\leq 2\text{dB}\mu\text{V}</math> (10dB S/N)          T98: <math>\leq -10\text{dB}\mu\text{V}</math> (BER 1%)          DMR: <math>\leq -7\text{dB}\mu\text{V}</math> (BER 1%)          D-STAR: <math>\leq -10\text{dB}\mu\text{V}</math> (BER 1%)          C4FM(DN): <math>\leq -7\text{dB}\mu\text{V}</math> (BER 1%)          AIS: <math>\leq -5\text{dB}\mu\text{V}</math> (BER 1%, 162MHz only)          WFM: <math>\leq -2\text{dB}\mu\text{V}</math> (12dB SINAD)</p> <p>Audio: Internal Speaker 400mW(10% distortion / 8<math>\Omega</math>)          External Terminal 40mW(10% distortion / 32<math>\Omega</math>)</p>
-----------	---

- \* Specifications are subject to change without notice.
- \* Reception sensitivity is a representative value. It may vary slightly depending on the frequency.
- \* As per FCC rules, the US T-version is cellular telephone frequencies not receivable and an analog voice descrambler deactivated. They are not firmware-modifiable nor commands-expandible.





DJ-X100T



DJ-X100E

Manufacturer:

## **ALINCO, INC.**

Yodoyabashi Dai-bldg 13F

4-4-9 Koraibashi, Chuo-ku, Osaka 541-0043 Japan

Phone: +81-6-7636-2362 Fax: +81-6-6208-3802

<http://www.alinco.com>

E-mail: [export@alinco.co.jp](mailto:export@alinco.co.jp)

Copyright Alinco, Inc.

PS1141

FNFH-EF