

DX-10

Instruction Manual

Thank you for purchasing your new Alinco transceiver.

Please read this manual carefully before using the product to ensure full performance, and keep this manual for future reference as it contains information on after-sales services. In case addendum or errata sheets are included with this product, please read those materials and keep them together with this instruction manual for future reference.



INTRODUCTION

Thank you very much for purchasing this excellent Alinco transceiver. Our products are ranked among the finest in the world. This radio has been manufactured with state of the art technology and it has been tested carefully at our factory. It is designed to operate to your satisfaction for many years under normal use.

Please read this manual completely from the first page to the last, to learn all the functions the product offers. It is important to note that some of the operations may be explained in relation to information in previous chapters. By reading just one part of the manual, you may risk not understanding the complete explanation of the function.

Before transmitting

There are many radio stations operating in proximity to the frequency ranges this product covers. Be careful not to cause interference when transmitting around such radio stations.

■ Lightning

Please note that no car provides adequate protection of its passengers or drivers against lightning. Therefore, Alinco will not take responsibility for any danger associated with using its radios or inside the car during lightning.



Check with your local waste officials for details on recycling or proper disposal in your area.

RoHS

Copyright © All rights reserved. No part of this document may be reproduced, translated or transcribed in any form or by any means without the prior permission of Alinco. Inc., Osaka, Japan.

Alinco and ALINCO logo are registered trademarks of Alinco incorporated, Japan in United States, EU States, Russia, China and many other countries. Windows is a registered trademark of Microsoft Corporation in the United States and other countries. All other trademarks are the properties of their respective holders.







ALINCO and authorized dealers are not responsible for any typographical errors there may be in this manual. The contents of this manual may be updated without any notice or obligation.

Alinco cannot be liable for pictorial or typographical inaccuracies. Changes or modifications not expressly approved by the party responsible for compliance could void the user's authority to operate the equipment.

ALINCO

WARNING









To prevent any hazard during operation of Alinco's radio product, in this manual and on the product you may find symbols shown below. Please read and understand the meanings of these symbols before starting to use the product.

 Danger	This symbol is intended to alert the user to an immediate danger that may cause loss of life and property if the user disregards the warning.
 Alert	This symbol is intended to alert the user to a possible hazard that may cause loss of life and property if the user disregards the warning.
 Caution	This symbol is intended to alert the user a possible hazard that may cause loss of property or injure the user if the warning is disregarded.
	Alert symbol. An explanation is given.
	Warning symbol. An explanation is given.
	Instruction symbol. An explanation is given.





ALERT

■ Environment and condition of use:





-  Do not drive while handling the radio for your safety. It is recommended that you check local traffic regulations regarding the use of radio equipment while driving.
Some countries prohibit the operation of transceiver while driving.



-  Do not use this product in close proximity to other electronics devices, especially medical ones. It may cause interference to those devices.
-  Keep the radio out of the reach of children.
-  In case a liquid leaks from the product, do not touch it. It may damage your skin.
Rinse with plenty of cold water if the liquid contacted your skin.
-  Never operate this product in facilities where radio products are prohibited for use such as aboard aircraft, in airports, in ports, within or near the operating area of business wireless stations or their relay stations.
-  Use of this product may be prohibited or illegal outside of your country. Be informed in advance when you travel.
-  The manufacturer declines any responsibilities against loss of life and/or property due to a failure of this product when used to perform important tasks like life-guarding, surveillance, and rescue.
-  Do not use multiple radios in very close proximity. It may cause interference and/or damage to the product(s).
-  The manufacturer declines any responsibilities against loss of life and property due to a failure of this product when used with or as a part of a device made by third parties.
-  Use of third party accessory may result in damage to this product. It will void our warranty for repair.

■ Handling this product:

-  Be sure to reduce the audio output level to minimum before using an earphone or a headset. Excessive audio may damage hearing.
-  Do not open the unit without permission or instruction from the manufacturer. Unauthorized modification or repair may result in electric shock, fire and/or malfunction.
-  Do not operate this product in a wet place such as shower room. It may result in electric shock, fire and/or malfunction.
-  Do not place conductive materials, such as water or metal in close proximity to the product. A short-circuit to the product may result in electric shock, fire and/or malfunction.
-  Do not touch the heatsink (on/around the unit mostly found on mobile-base units) as it may become very hot during/after the operation that may risk burn your skin.

■ About power-supply:



-  Use only appropriate, reliable and certified power supply of correct voltage and capacity.
-  Do not connect cables in reverse polarity. It may result in electric shock, fire and/or malfunction.
-  Do not plug multiple devices including the power-supply into a single wall outlet. It may result in overheating and/or fire.
-  Do not handle a power-supply with a wet hand. It may result in electric shock.
-  Securely plug the power-supply to the wall outlet. Insecure installation may result in short-circuit, electronic shock and/or fire.

-  Do not plug the power-supply into the wall outlet if the contacts are dirty and/or dusty. Short circuiting and/or overheating may result in fire, electric shock and/or damage to the product.
-  Do not modify or remove fuse-assembly from the DC-cable. It may result in fire, electric shock and/or damage to the product.

■ In case of emergency:

In case of the following situation(s), please turn off the product, switch off the source of power, then remove or unplug the power-cord. Please contact your local dealer of this product for service and assistance. Do not use the product until the trouble is resolved. Do not try to troubleshoot the problem by yourself.





- When a strange sound, smoke and or strange odor comes out of the product.
- When the product is dropped or the case is broken or cracked.
- When a liquid penetrated inside.
- When a power-cord (including DC-cables, AC-cables and adapters) is damaged.

-  For your safety, turn off then remove all related AC-lines to the product and its accessories including the antenna if a thunderstorm is likely.
-  Turn off the unit, remove the mobile antenna from its base and keep it in the vehicle if a thunderstorm is likely. Please read cautions regarding the lightning-protection on first page also.



■ Maintenance

-  Do not open the unit and its accessories. Please consult with your local dealer of this product for service and assistance.





 **CAUTION****■ Environment and condition of use:**

-  Do not use the product in proximity to a TV or a radio. It may cause interference or receive interference.
-  Do not install in a humid, dusty or insufficiently ventilated place. It may result in electric shock, fire and/or malfunction.
-  Do not install in an unstable or vibrating position. It may result in electric shock, fire and/or malfunction when/if the product falls to the ground.
-  Do not install the product in proximity to a source of heat and humidity such as a heater or a stove. Avoid placing the unit in direct sunlight.

■ About transceiver

-  Do not connect devices other than specified ones to the jacks and ports on the product.
It may result in damage to the devices.
-  Turn off and remove the power-source (AC cable, DC cable, battery, cigar-cable, charger adapter etc) from the product when the product is not in use for extended period of time or in case of maintenance.
-  Use a clean, dry cloth to wipe off dirt and condensation from the surface of the product.
Never use thinner or benzene for cleaning.

■ About power-supply

-  Use only reliable power supply of specific DC output range and be mindful of the polarity of the cables and DC jack.
-  Always turn off the power supply when connecting or disconnecting the cables.
-  When using an external antenna, make sure that the antenna ground is not common with the ground of the power supply.
-  When a transceiver is powered from an external DC power source (adapter, power supply, cigar-plug etc), make sure that this power supply has approval to the level of IEC/EN 60950-1.



Check with your local waste officials for details on recycling or proper disposal in your area.

■ PC PROGRAMMING

NOTE: The utility software may be available to distributors/dealers only. USB programming cable is required. The manufacturer will not release the software to unauthorized party so please contact your dealer for details.

Available features in this product may not be usable in your country due to your local regulations. Please consult with your dealer before purchase.

■ Optional Accessories

* Plain microphone EMS-70 (spare)

■ Warranty Policies

Please consult with your dealer before purchase.

ALINCO

STANDARD ACCESSORIES.....	1
FUNCTIONS & FEATURES.....	1
WARNING.....	1
RESET FUNCTION (Resume Factory Default).....	1
INSTALLLATION.....	2
HOW TO USE YOUR RADIO.....	4
FUNCTION MENU SETUP.....	8
OPERATING PROCEDURE TO RECEIVE.....	11
OPERATING PROCEDURE TO TRANSMIT.....	11
SPECIFICATIONS.....	12
TROUBLE SHOOTING.....	13

■ STANDARD ACCESSORIES

The following accessories are supplied with this product. Please confirm that nothing is missing before using.

* Main unit * DC-cable * Microphone EMS-70 * Cradle and fixing hardware

* Instruction manual (this booklet)

NOTE: Included accessories may vary depending on the market of distribution and/or dealers' sales policies. Please consult with your local dealer for details before purchase.

■ FUNCTIONS & FEATURES

1. Big LCD which displays frequency and all kinds of information
2. DUAL-DIGITAL TUBE FOR CHANNEL DISPLAY
3. USE EL technology for backlight
4. PA, CW, AM, FM, USB, LSB modes
5. A, B, C, D, E, F, 6 bands in total, with 60 channels at most in each band to be programmed.
6. Frequency Tuning Step can be 10Hz, 100Hz, 1KHz or 10KHz.
7. Multiple CLARIFIER Operating Modes
8. Flexible menu functions and PC programming software
9. ECHO Function
10. RF GAIN ADJUSTMENT
11. RF PWR ADJUSTMENT
12. SCAN FUNCTION
13. RB FUNCTION
14. NB/ANL FUNCTION
15. DW DUAL-WATCH FUNCTION
16. BEEP VOICE PROMPT
17. +10KHz Function

18. SWR, S/RF, DC Voltage display function

19. TOT function

20. HI-CUT FUNCTION

21. EMG CALL

22. SWR PROTECTION

23. POWER SUPPLIED VOLTAGE PROTECTION

24. Key-Lock Function

25. 7colors LCD back light

■ WARNING

To use the radio, please connect the antenna to the location "B" on the back panel of the equipment firstly and then set the SWR (Standing Wave Ratio) before transmitting. Failure to do so may result in destruction of the power amplifier, which is not covered by the guarantee.

■ RESET FUNCTION (Resume Factory Default)

This Radio introduces RESET FUNCTION to prevent accidents and provide a solution for customers who changed some functions unconsciously and do not know how to resume normal settings. The Radio will resume factory default once this function is activated.

How to Operate:

Step 1: Power off the radio.

Step 2: Press and hold FUNC and SCAN keys at the same time, followed by powering on the radio.

Step 3: Release the two keys when LCD displays "RES".

All former settings would be replaced by Factory Default value when LCD displays "REND".

WARNING: All former settings would be replaced by Factory Default value after operating the RESET FUNCTION.

■ INSTALLATION

1. WHERE AND HOW TO MOUNT YOUR RADIO

- You should choose the most appropriate setting from a simple and practical point of view.
- Your radio should not interfere with the driver or the passengers.
- Remember to provide different wires for passing and protection. (e.g.: power, antenna, accessory cabling) so that they do not in any way interfere with the driving of vehicles.
- To install your equipment, use the cradle ① and the self-tapping screws ② provided (drilling diameter 5 mm). Take care not to damage the vehicle's electrical system while drilling the dash board.
- Do not forget to insert the rubber joints ③ between the radio and its support as these have a shock-absorbing effect which permits gentle orientation and tightening of the set.
- Choose where to place the microphone support and remember that the microphone cord must stretch to the driver without interfering with the controls of the vehicle.

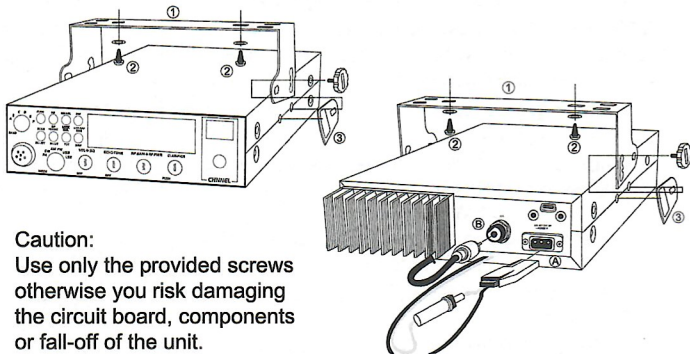

Caution:
Use only the provided screws otherwise you risk damaging the circuit board, components or fall-off of the unit.

2. ANTENNA INSTALLATION

a) Choosing your antenna:

For radios, the longer the antenna, the better its results. Your dealer will help you with your choice of antenna.

b) Mobile antenna:

-Must be fixed to the vehicle where there is a maximum of metallic surface (ground plane), away from windscreen mountings.

-There are two types of antenna: Pre-Regulated Antenna which should be used on a good ground plane (e.g. car roof or lid of the boot), and Adjustable Antenna which offer a much larger frequency range and can be used on a smaller ground plane.

For an antenna which must be fixed by drilling, you will need a good contact between the antenna and the ground plane. To obtain this, you should lightly scratch the surface where the screw and tightening star are to be placed.

-Be careful not to pinch or flatten the coaxial cable (as this runs the risk of break down and/or short circuiting).

-Connect the antenna to location ⑥.

c) Fixed antenna:

A fixed antenna should be installed in a space as clear as possible. If it is fixed to a mast, it will perhaps be necessary to stay it, according to the laws in force (you should seek professional advice).

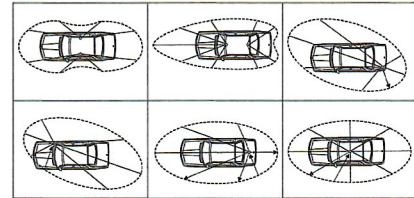

IMPORTANT: RF Hazard Warning

The electro-magnetic exposure of this device may exceed the European standards of the hazard level depending on the conditions of the combination of the antenna gain, distance from the operator, output setting and installation environment. For safety purpose, it is recommended that the antenna be installed outside of, and as far as possible from, the operator's area. Avoid using an excessively high-gained antenna in case the distance between the operator and the antenna is very limited.

Always use the minimum necessary output power for communications.

3. POWER CONNECTION

Your RADIO is protected against an inversion of polarities. However, before switching it on, you are advised to check all the connections. Your equipment must be supplied with a continued current of 12 volts. Today, most cars and lorries are negative earth. You can check this by making sure that the negative terminal of the battery is connected either to the engine block or to the chassis. If this is not the case, you should consult your dealer.

WARNING: Lorries generally have two batteries to supply a voltage of 24 volts, in which case it will be necessary to insert a 24/12 volt converter into the electrical circuit. The following connection steps should be carried out with the power cable disconnected from the set.

- a) Check whether the battery is of 12 volts.
- b) Locate the positive and negative terminals of the battery (+ is red and - is black). Should it be necessary to lengthen the power cable, please use the same or a superior type of cable.
- c) It is necessary to connect your radio to a permanent (+) and (-). We advise you to connect the power cable directly to the battery (as the connection of the cable to the wiring of the car-radio or other parts of the electrical circuit may, in some cases, increase the possibilities of interference).
- d) Connect the red wire (+) to the positive terminal of the battery and the black (-) wire to the negative terminal of the battery.
- e) Connect the power cable to your radio. Ⓐ

WARNING: Never replace the original fuse (10A) by one of a different value.

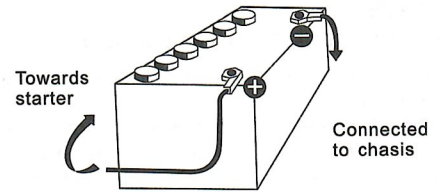

4. BASIC OPERATIONS TO BE CARRIED OUT BEFORE USING YOUR RADIO FOR THE FIRST TIME (without transmitting or using the PTT (Push-To-Talk) key on the microphone)

- a) Connect the microphone
- b) Check the antenna connections
- c) Turn the set on by turning the volume knob clockwise
- d) Turn the squelch knob to minimum
- e) Adjust the volume to a comfortable level
- f) Go to channel 20@D band by using either the UP or DN key on the microphone or the rotary knob.

5. ADJUSTMENT OF SWR(standing wave ratio)

WARNING: This must be carried out when you use your radio for the first time (and whenever you re-position your antenna). The adjustment must be carried out in an obstacle-free area.

Adjustment with a built-in SWR meter or external SWR meter

- a) To connect the SWR meter
Connect the SWR meter between the radio and the antenna as close as possible to the radio (use a maximum of 40cm cable).
- b) To adjust the SWR meter
 - Set the radio to channel 20@D band in FM.
 - put the switch on the SWR meter to position CAL or FWD.
 - Press the PTT (Push-To-Talk) key on the microphone to transmit.
 - Bring the index needle to ▼ by using the calibration key.

- Change the switch to position SWR (reading of the SWR level). The reading on the meter should be as near as possible to 1. If this is not the case, re-adjust your antenna to obtain a reading as close as possible to 1. (An SWR reading between 1 and 1.8 is acceptable).
 -It will be necessary to re-calibrate the SWR meter after each adjustment of the antenna.

6. HOW TO USE INTERNAL SWR METER

-Set to channel 20@D band in FM.
 -Press the PTT key on the microphone to transmit.
 -At the moment, LCD would display SWR value which should be as close as possible to 1. If this is not the case, re-adjust your antenna to obtain a SWR value as close as possible to 1 (an SWR reading between 1 and 1.8 is acceptable).

■ HOW TO USE YOUR RADIO

<LCD Display>

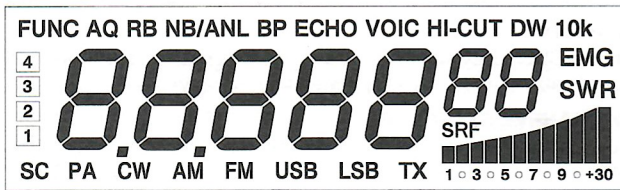

7 digits: Display frequency and any other information.

Indicating bars: Indicate RX RSSI, PWR, SWR.

The first decimal point: Appears when current channel is edited with SCAN DEL.

FUNC: Appears after pressing FUNC key.

RB: Appears when Roger beep function is started (enabled).

NB/ANL: Appears when NB/ANL function is started (enabled).

BP: Appears when BP function is started (enabled).

ECHO: Appears when ECHO function is started (enabled).

VOIC: Appears when VOIC function is started. It is disabled in this radio.

HI-CUT: Appears when HI-CUT function is started.

DW: Appears when DW function is started.

TX: Appears when radio is transmitting.

10K: Appears when +10KHz function is started.

EMG: Appears when EMG channel is used.

SWR: Appears when SWR is used.

SRF: Appears when S/R/F is used.

SC: Appears when SCAN is used.

PA, CW, AM, FM, USB, LSB: Indicate different operating modes.

1. Appears when CLARIFIER function is FINE operation.
2. Appears when CLARIFIER FUNCTION is COARSE operation or RT operation.
3. Appears when CLARIFIER FUNCTION is transmitting frequency regulated.

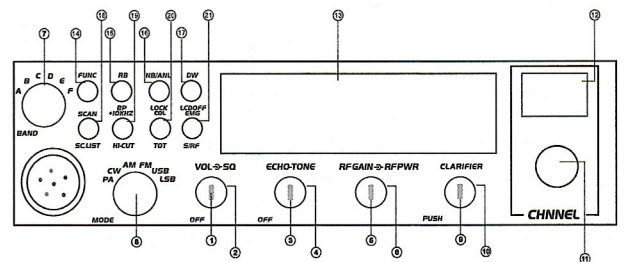

<FRONT PANEL>

1. OFF/ON/VOLUME(Inner Dual Concentric)

Turn clockwise to switch on the radio and set desired volume level. Under normal operating state, the VOLUME control is used to adjust the output volume obtained either by the transceiver speaker or the external speaker or the external PA speaker, if used.

2. SQUELCH (Outer Dual Concentric)

This control is used to cut off or eliminate receiver background noise in the absence of an incoming signal. For maximum receiver sensitivity, it is desired that the control be adjusted only to the point where the receiver background noise or ambient background noise is eliminated. Turn fully anticlockwise then slowly clockwise until the receiver noise disappears. Any signal to be received must now be slightly stronger than the average received noise. Further clockwise rotation will increase the threshold level which a signal must overcome in order to be heard. Only strong signals will be heard at a maximum clockwise setting.

3. ECHO(Inner Dual Concentric)

This knob is used to control echo effect.

4. TONE (Outer Dual Concentric)

This knob is used to control intervals of echo sound

5. RF GAIN (Inner Dual Concentric)

This knob is for adjusting sensitivity during reception. For long distance communications RF GAIN should be set to maximum. RF GAIN can be reduced to avoid distortion, when your correspondent is close by and when he does not have RF POWER. The normal setting of this function is on maximum (fully clockwise).

6. RF POWER (Outer Dual Concentric)

Adjustment of the output power is for AM and FM mode only. Reducing the power is allowed when communicating with a person who has no

RF GAIN. The normal position of this function is set to maximum, fully clockwise.

7. BAND SELECTOR

Rotate this knob to select A, B, C, D, E, F band of operation

8. MODE(PA/CW/AM/FM/USB/LSB)

This knob allows selecting the modulation mode PA, CW, AM, FM, LSB or USB. Your modulation mode has to correspond with the one of your correspondent. The mode selector changes the mode of operation of both transmitter and receiver simultaneously.

Frequency Modulation/FM: for nearby communications on a flat open field.

Amplitude Modulation/AM: Communication on a field with relief and obstacles in middle distance (the most used).

Upper and Lower Side Band/USB-LSB: Used for long distance communications (according to the propagation conditions).

9. CLARIFIER

This is frequency tuning knob which can be set as different modes (refer to CLA Specifications in Functions Menu for more details).

10. PUSH

This is PUSH Key which can be set as different modes (refer to PSH specifications under Functions Menu for more details).

11. CHANNEL SELECTOR

Rotate this knob to select any desired channel from forty citizens band channels. The selected channel appears on the LED directly above the channel selector knob.

12. CHANNEL INDICATOR

Numbered LED indicates the selected channel to operate on.

13. LCD DISPLAY

Display frequency, all kinds of information and icons.

14. FUNC

This is functional key. Press and hold this key for 2seconds to enter into Functions Menu Setup (refer to Functions Menu for more details). Press FUNC key and other individual key to realize the second functions silk-screened under the button. For example, press FUNC key followed by pressing RB key to realize the BP function. Press FUNC key followed by DW to realize the LCD OFF function.

Details operations are as bellows:

Press FUNC key, "FUNC" icon will appear on LCD display. Release FUNC key, and then press other keys to realize the second functions silk-screened under the button. "FUNC+ Keypad name" is to be used in the following operating instruction.

15. ROGER BEEP OR BEEP FUNCTION

(1) RB

Press "RB" key to enable "ROGER BEEP" function with "RB" icon appearing on LCD display. Press the key repeatedly to switch on/off the function.

When RB function is enabled, the radio will automatically transmit the audio signal at the end of your transmission. The listener can note easily that your transmission is over through the signal.

(2) FUNC+RB

Press FUNC+RB to realize BP Function. It is a prompting function with "BP" icon appearing on LCD display. Speaker would emit a BEEP for prompting when press any key. press FUNC+RB repeatedly to switch on/off the function.

16. NB/ANL or LOCK

(1) Press NB/ANL key to enable NB/ANL function with "NB/ANL" icon appearing on the LCD display. Press the key repeatedly to switch on/off the function.

Noise Blanker/Automatic Noise Limiter. These filters allow reducing back ground noises and some reception interferences.

(2) FUNC+NB/ANL

Press FUNC+NB/ANL to realize the Keyboard Lock function. When this function is enabled, all keys are invalid except PTT, BAND SWITCH, and MODE SWITCH. When pressing any key except PTT, BAND SWITCH, MODE SWITCH, the LOCK icon will display on the LCD. These situations indicate that the keyboard has been locked. Press FUNC+NB/ANL repeatedly to switch on/off the function.

17. DW or LCD OFF

(1) The DW (dual watch) function allows automatic alternate monitoring of two channels. Refer to the following procedures to enable this function.

To enable the DW function, firstly turn the SQ control clockwise until the background noise is cut out. Select the first channel to be monitored by using the CHANNEL SELECTOR knob or the channel selector keys on the microphone. Press the DW key and the DW icon will flash on the LCD display. Secondly, follow the above procedures to select second channel to be monitored. Finally, press the DW key again and the two monitoring channels will be alternately indicated on the LCD. Radio will automatically start monitoring (scanning) the two channels. When a signal is detected on one of the channels, scanning stops and it is possible to listen the communications on that channel. Press PTT to transmit on this channel. If there is no transmission or detected signal on that channel within 5 seconds (time to resume scanning can be programmed by PC software), radio will resume scanning. When the DW function is enabled, the DW icon appears on the LCD. To exit the DW function, press the DW key or the PTT key.

The scan Type above is the SQ mode under SCA Selection in Function Menu. If TI mode is selected and valid signal is detected, the radio would still start scanning when it is time to resume scanning, whether there is signal or not in current channel.

(2) FUNC+DW

When this function is enabled, LCD display would be switched

OFF(LCD OFF).

Repeat this operation to switch ON/ OFF the function.

18. SCAN OR Scan.list

(1) SCAN

Automatic Scanning of busy channels.

Press the SCAN key to enable the SCAN function. Before enabling the SCAN function, firstly turn the SQ control clockwise till the background noise is cut out. Then press the SCAN key, radio will automatically scan all channels continuously in the scan list and the SC icon will appear on the LCD.

When a signal is detected on a channel, scanning stops on this channel. You can receive the calling, and also, can transmit on this channel by pressing PTT key. If there is no transmission or detected signal on that channel within 5 seconds(time to resume scanning can be programmed by PC software), radio will start scanning again. To exit the SCAN function, press the SCAN key or the PTT key.

The Scan Type above is the SQ mode under SCA Selection in Function Menu. If T1 mode is selected and valid signal is detected, the radio would still start scanning when it is time to resume scanning, whether there is signal or not in current channel.

(2) FUNC+SCAN

SC.LIST (Scan ADD or Delete). Press FUNC+SCAN to delete current channel from scan list. The first digit on LCD would display. When Scan function is enabled, the radio would skip the deleted channel. Repeat this operation to Add or Delete channels from scan list.

19. +10KHz or HI-CUT

(1) +10KHz Press this key to shift frequency up by 10KHz.

When pressing this key, 10KHz would appear on LCD and frequency of channels is shifted up by 10KHz. Repeat this operation to switch ON/OFF this function.

(2) FUNC + 10KHz

Press FUNC+10KHz to realize HI-CUT function. Once this function is enabled, the radio would cut out high frequency interference. Its use depends on reception conditions.

When this function is enabled, "HI-CUT" would appear on LCD. Repeat this operation to switch ON/OFF the function

20. COL OR TOT

(1) COL

a. When pressing this key, LCD backlight can be switched and circulate, total 7colors.

b. When pressing this key and hold 2seconds, SWR function will be switched on.

"SWR" icon would appear on the LCD. When transmitting, SWR bars indicate SWR value. One bar displaying on the LCD indicates that SWR value is 1.0. Each additional bar indicates every 0.1 added value. Pressing this key and hold 2seconds to switch off SWR function.

(2) FUNC+ COL

When pressing this key, TOT ON or TOT OFF would display on the LCD for 2 seconds. Repeat this operation to switch ON/OFF the function. When ON appears on the LCD, users can press PTT to transmit. Then, the radio would time the transmitting duration. Once the duration is beyond the set TOT time (programmable), the radio would emit voice prompt and stop transmitting and back to receiving state automatically. This function aims to protect the radio against power tube damage from superheating caused by long transmission.

21. EMG OR S/RF

(1) EMG realizes Emergency Channel Call. When emergent situation happens, the radio would switch to the channel set in advance to communicate immediately. Then the "EMG" icon would display on the LCD. Press EMG key again to return to previous channel.

(2) FUNC + S/RF

S/RF is the key of TX's or RX's S/RS indicating bar. When this function is enabled, "SRF" icon would display on the LCD. Repeat the this operation to key ON/OFF the function.

<Rear Panel>

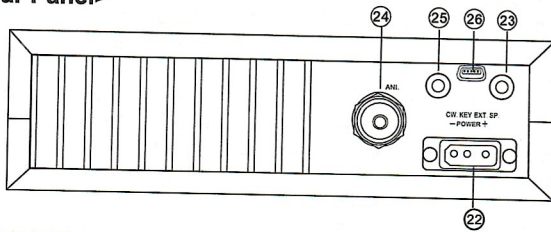

22. POWER

Accept 13.8V DC power cable with built-in fuse (10A) to be connected.

23. EXT SP or PA SP

EXT SP

Accept 4 to 8 ohm, 4 watt external speaker to be connected. When external speaker is connected to this jack, the built-in speaker is automatically disconnected.

PA SP

It is used to connect a PA speaker. Before operating PA, you must firstly connect a PA speaker to this jack.

24. ANTENNA

Accept 50 ohm coaxial cable with a type PL-259 plug to be connected.

25. CW KEY

This jack is for Morse code operation; To operate, connect a CW key to this jack and place the MODE switch in the CW position (LCD display icon "CW").

26. Programming

This jack is for PC program, accept programming cable to be connected.

<MICROPHONE>

The receiver and transmitter are controlled by the PTT (Push-To-Talk) key on the microphone.

Press the key to transmit and then release it to receive. When transmitting, hold the microphone two inches from the mouth and speak clearly in a normal "voice".



1. PTT

Press the PTT (Push-To-Talk) key to transmit.

2. UP/DN

These key allow increasing or decreasing a channel number.

3. MICROPHONE

The radios come complete with impedance 2k ohm microphone.

FUNCTION MENU SETUP

The initial functions and parameter can be changed via the following settings and operations. Please read the following instruction before making any desired amendments.

To enter Function Menu: Under ON state, press and hold FUNC key for more than 2seconds, and then release the FUNC key to enter into the Function Menu Setup. Under this condition, press FUNC key to select different functions menu, CHANNEL SELECTOR knob to change the data of Function Menu.

(1) STP (Frequency Tuning Step)

This menu is to set tuning step when adjusting frequency by CLARIFIER knob.

Options: 10Hz、100Hz、1KHz、10KHz

Default: 10Hz

STP 10

(2) CLA (CLARIFIER knob functions setting)

This menu is to set functions turned by CLARIFIER knob. Options are as follows:

FIN: Fine regulation. When this option is selected, users can fine tuning the receiving frequency by rotating the CLARIFIER knob. In tuning process, the transmitting frequency can not be regulated by the knob and "1" icon will appear on the LCD.

RT: When this option is selected, users can regulate the frequency of both transmitting and receiving. In tuning process, "2" icon will appear on the LCD.

T: When this option is selected, users can only regulate the transmitting frequency. In tuning process, "3" icon will appear on the LCD.

Default: RT

CLA rt

(3) PUS (PUSH Function Setting)

This menu is to set functions realized via PUSH knob. Options are as follows:

COA: When this option is selected, press PUSH and turn CLARIFIER knob to realize COARSE function.

PUS STP

When pressing this key, "2" icon will appear on far left of the LCD. Under this condition, rotate the CLARIFIER knob to change frequency of both transmitting and receiving.

T: When this option is selected, press PUSH and turn CLARIFIER knob to change transmitting frequency. When pressing this key, "3" icon will display on the far left of the LCD. Under this condition, rotate the CLARIFIER knob to change the transmitting frequency only.

STP: When this option is selected, PUSH function will change Frequency Tuning Step of CLARIFIER knob. Press this key, then the corresponding frequency bit would blink.

Default: STP

(4) TOT (Transmitting Time-Out-Timer)

This menu is to set transmitting TOT time. When pressing PTT key at a single time longer than the due time setup in advance, the radio would stop transmitting automatically and loudspeaker will emit voice prompt till PTT key is released. Then, the radio can transmit again.

Options: 30-600s **Step:** 30s

Default: 180s

TOT 180

(5) SC Scanning Type Selection

This menu is to set Scan Type. Options are as follows:

SQ: When SQ is selected, scan would stop when a valid signal is detected. The radio would resume scanning after signal disappears for 5s.

SC SQ

TI: When TI is selected, scan would stop when a valid signal is detected. The radio would resume scanning 5 seconds later, whether signal disappears or not.

Default: SQ

(6) TSR (Transmitting SWR Protection)

tsr on

This menu is to choose whether to enable Transmitting SWR Protection function or not.

ON: When ON is selected, the radio will detect the SWR of antenna. Once the SWR is beyond the SWR set in advance, the radio would prohibit transmitting automatically and loudspeaker will emit voice prompt. Then, "HI S" icon will display on the LCD to remind you that the antenna SWR is too high or antenna do not connect well.

OFF: When OFF is selected, SWR Protection function is disabled.

NOTE: To protect the radio from long transmission under high SWR, the radio would automatically start SWR Protection once the SWR Value is higher than 20:1.

Default: ON (SWR=<10:1)

(7) TDC (Power Supplied Voltage Protection)

tdc on

This menu is to choose whether to enable Power supplied Voltage Protection function or not.

ON: When ON is selected, the radio will detect the supplied voltage. Once the voltage surpasses the voltage setup in advance, the radio would display "DC LO" or "DC HI" to remind you that the voltage is not in normal state. Meanwhile, the radio will prohibit transmitting and emit beep prompt.

OFF: When OFF is selected, the Power Supplying Voltage is disabled.

Default: ON (DC 10.5V-16V)

(8) TLD (Content displayed on the LCD when transmitting)

tld tf

This menu is to set the content displayed on the LCD when transmitting.

TF: When TF is selected, LCD would display transmitting frequency when transmitting.

SR: When SR is selected, LCD would display SWR value of antenna when transmitting, for example: "1.2" on the LCD.

BAT: When BAT is selected, LCD would display Supplied Voltage when transmitting, for example: "13.8DC" on the LCD.

TOT: When TOT is selected, LCD would display TOT remaining time when transmitting. And TOT would count down till remaining time is 0, for example: "170" displayed on the LCD display.

Default: TF

(9) RBF (ROGER BEEP Frequency Setting)

rbf 1050

This menu is to select frequency of Roger Beep. The frequency range is 300Hz—3KHz. The shift step is 10Hz.

Default: 1050Hz

(10) RBT (ROGER BEEP Holding Time)

rbt 500

This menu is to select Roger Beep Holding Time from 50ms - 1000ms. The shift step is 50ms.

Default: 500ms

(11) CFR (CW Side Tone Frequency)

CFR 1050

This menu is to select CW Side Tone Frequency from 300Hz-3kHz, the shift step is 10Hz.
Default: 1050Hz.

(12) TON (Transmitting Single-Tone Frequency)

This menu is to select Transmitting Single-Tone Frequency from 300Hz-3kHz. The shift step is 10Hz.
Default: 1050Hz

ton 1050

(13) NOG

It refers to TX MON function. Users can set the volume and grade of the TX MON by software. The higher grade goes to louder TX MON. 64 grades in total (OFF,0-63)
Default: OFF

n09 15

(14) CSV

This menu is to adjust the side voice of CW SIDE VOL CW. 64 grades in total. Default: 31.

CSV 255

(15) ICG

This menu refers to MIC GAIN function. Users can set the value by software. The higher value goes to higher sensitivity. 64 grades in total (OFF,0-63).
Default: 5

ICG 31

(16) BEU

This menu is to set the volume of beep. 64 grades in total(OFF,0-63).
Default: 31

BEU 255

■ OPERATING PROCEDURE TO RECEIVE

1. Be sure that power supply, microphone and antenna are connected to the proper connectors before going to the next step.
2. Turn the radio on by tuning VOLUME control clockwise.
3. Rotate the VOLUME knob to set a comfortable listening level.
4. SET the MODE knob to the desired mode.
5. Set the CHANNEL selector knob to select the desired channel.
6. Set the RF gain control full clockwise to maximum RF gain.
7. Listen to the background noise from the speaker. Turn the SQUELCH control clockwise slowly until the noise disappears (no signal should be present). Leave the control at this setting. The Squelch is now properly adjusted. The receiver will remain quiet until a signal is actually received. Do not advance the control too far, or some of the weaker signals can not be heard.

■ OPERATING PROCEDURE TO TRANSMIT

1. Select the desired channel of transmission.
2. Press the PTT key on the microphone and speak in a normal voice.

SPECIFICATIONS

General	
Frequency Range	28.000MHz—29.700MHz
Operating mode	SSB/CW/AM/FM
Channel	Up to 60ch per bank, 6 banks
Frequency Step	10Hz 100Hz 1KHz 10KHz
Frequency Stability	±1ppm
Temperature Range	-30°C to +50°C
Microphone impedance	2kΩ
Rated voltage	DC 13.8V ±15%
Dimensions	170(W) X 52(H) X 215(D) mm
Current	transmit: 6A Max Receive: 800mA(Max) 400mA(squelched)
Ground	negative ground
Weight	Approx. 1.4kg
Antenna impedance	50Ω unbalanced
TRANSMITTER	
Power Output	FM/AM/CW:1-12W(adjustable) USB/LSB:0-25W(adjustable)
Modulation	AM:Amplitude modulation FM:Variable reactance frequency modulation SSB:Balanced modulation
Spurious emission	Less than -50dB
Maximum FM deviation	+/-2.5KHz

RECEIVE	
Circuitry	Double conversion superheterodyne
Sensitivity	SSB: 0dBu(1uV) CW: -12dBu(0.25uV) AM: +6dBu(2uV) FM: -6dBu(0.5uV)
Selectivity	SSB, CW, AM(narrow): 2.4KHz/-6dB 4.5KHz/-60dB AM, FM: 6KHz/-6dB 18KHz/-60dB
Intermediate frequency	AM/FM: 10.695 MHz 1st IF, 455 KHz 2nd IF SSB: 10.695 MHz
Audio Output	3W (8Ω, 10% TDD)
Intermodulation rejection ratio	More than 65dB
Spurious and image rejection ration	>48dB

* All specifications are subject to change without notice or obligation.

■ TROUBLE SHOOTING

Problem	Possible Causes and Potential Solutions
(a) Power is on, nothing appears on Display.	Polarities of power connection are reversed. Connect red lead to positive terminal and black lead to negative terminal of DC power supply.
(b) Fuse is blown.	Check and solve problem resulting in blown fuse and replace fuse with new fuse.
(c) No sound comes from speaker.	Squelch is muted. Decrease squelch level.
(d) Key and Dial do not function.	Key-lock function is activated. Cancel Key-lock function.
(e) PTT key is pressed but transmission does not occur.	<ul style="list-style-type: none">• Microphone connection is poor. Connect microphone properly.• Antenna connection is poor. Connect antenna properly.

13

If a problem should occur, first try the troubleshooting procedure given above. If the problem persists, contact your nearest ALINCO dealer for technical assistance.

ALINCO



Hereby, ALINCO, INC. declares that the radio equipment type DX-10 is in compliance with Directive 2014/53/EU.

The full text of the EU declaration of conformity is available at the following internet address: <http://www.alinco.com/Ce/>

ALINCO, INC.

Yodoyabashi Dai-bldg 13F

4-4-9 Koraibashi, Chuo-ku, Osaka 541-0043 Japan

Phone: +81-6-7636-2362 Fax: +81-6-6208-3802

<http://www.alinco.com>

E-mail: export@alinco.co.jp



RoHS

Copyright Alinco, Inc. PS0823 / FNEH-NI
Printed in China