

**HF MULTI-BAND WIRE DIPOLE (TRAP DIPOLE) ANTENNAS**

**W-SERIES**

**W-8010** 80m/40m/20m/15m/10m Five Band Trap Dipole Antenna

**W-735** 80m/40m Dual-Band Trap Dipole Antenna

**W-721** 40m/15m Dual-Band Trap Dipole Antenna

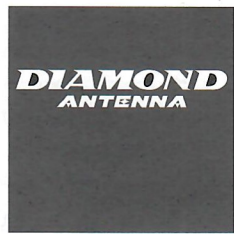

**OPERATION INSTRUCTIONS**

● **Parts List**

Each model contains the following parts in the package. Please confirm each part according to the list.

	W-8010	W-735	W-721
BU50A BALUN with two screws,nuts and washers	1	1	1
80m trap	2	2	-
40m trap	2	-	2
20m trap	2	-	-
Wire element A 3.75m (12.3')	2	-	-
Wire element B 4.2m (13.8')	2	-	-
Wire element C 2.8m (9.2')	2	-	-
Wire element D 2.8m (9.2')	2	-	-
Wire element E 1.4m (4.6')	2	-	-
Wire element F 10.95m (35.9')	-	2	-
Wire element G 2.9m (9.5')	-	2	-
Wire element H 3.75m (12.3')	-	-	2
Wire element I 3.4m (11.2')	-	-	2
Adjustment element 0.4m (1.3')	6	2	2
Insulator	4	2	2
Nylon rope 10m (32.8')	2	1	1
Self-melting plastic sealing tape 0.3m (1.0')	1	1	1
Binding wire 0.6m (2.0')	2	1	1

● **Description**

1. The W-Series antennas are very easy to assemble. And,low stretch ratio,rugged and weather proof 3.5 square plastic coated stranded wire is employed for element material.
2. Adjustment element is provided for each band to adjust each band without affecting rest of the bands.
3. Completely molded wideband balun enables perfect weather proof performance.

● **Assembled antennas**

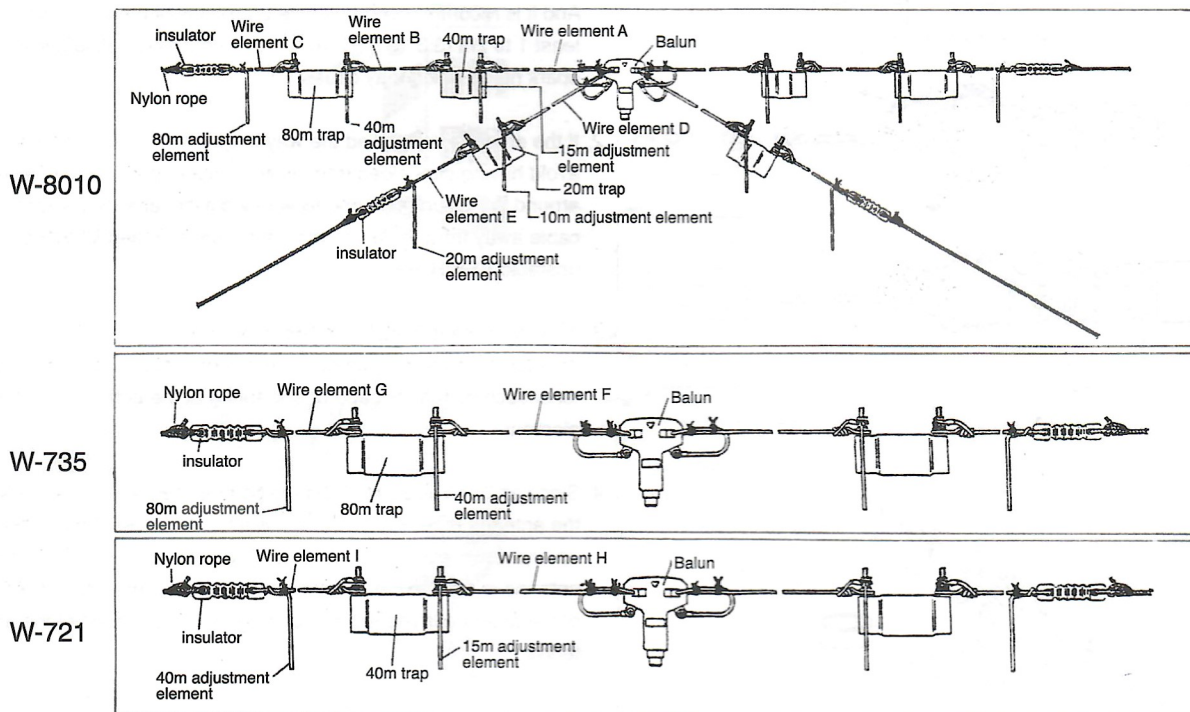

FIG.1

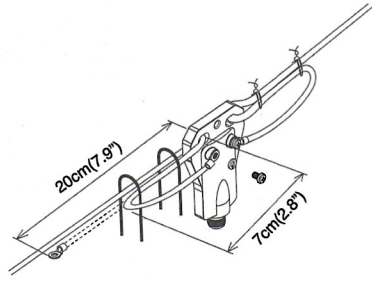

FIG.2

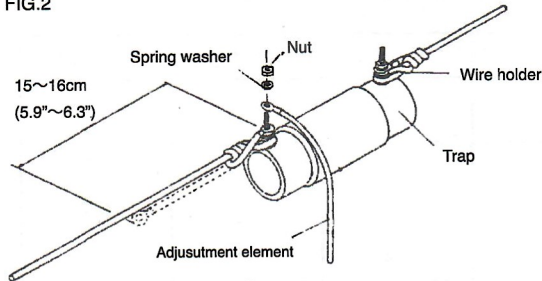

FIG.3

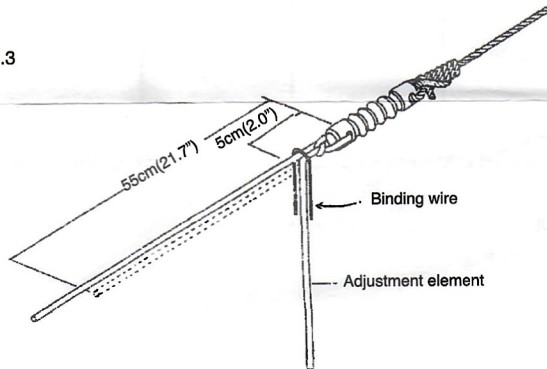

FIG.4

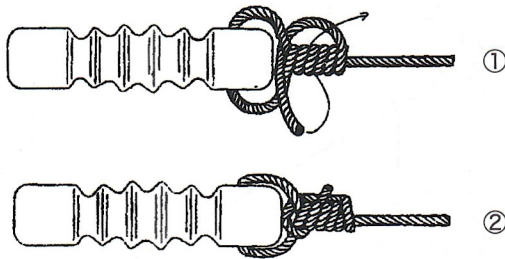
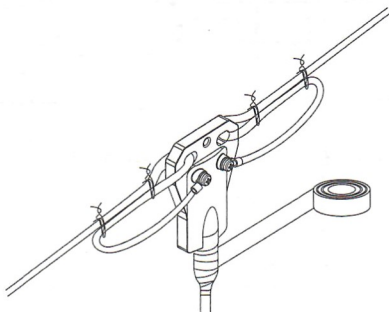

FIG.5



### ● Assembly

The antennas are assembled as shown per figures.

1. Turn wire element approximately 20cm(7.9")through balun and bind two parts by binding wire as shown per Fig.1. In case of the W-8010, two wire elements for one side are bind together.  
Note : Cut binding wire for approximately 10cm(3.9")each to bind.

2. To install a trap, turn a wire element approximately 15-16cm (5.9" to 6.3"),and then hook the element to wire holder section of the trap and turn crimped terminal side of the element four times around the other side of the element. Put crimped terminal through wire holder and fix with nut and spring washer. (Each adjustment element is to be set at balun side of each trap.)

3. To install a insulator, put a element approximately 55cm(21.7") through the insulator and tie the element once as shown per Fig.3. Then bind the element with binding wire as shown per Fig.3.

Note : Since each wire element is being affixed with its own cord, assemble the antenna by referring to each assembled antenna figure.

Note : Set adjustment element downward to avoid effecting resonant frequency of the main element. And at insulator section at both ends, rest of 55cm(21.7") turned back becomes an adjustment element.

Note : Tie an insulator and nylon rope firmly as shown per Fig.4.

4. Finally, connect 50Ω coaxial cable to the balun. To make connector section waterproof, wrap around self-melting adhesive plastic tape supplied by stretching it about two times. Ten wrap around conventional plastic tape to ensure it.(Fig 5)

### ● Installation

There are various ways of installing the antenna depending on the place where it is installed. In any case, take the following points into account.

1. Since maximum voltage occurs at both ends of the antenna in transmission, touching these points may lead to electric shock. And it is recommended to locate both ends of the antenna at least 1 to 2m (3.3' to 6.6') away from a building wall to avoid spark noise which may cause TVI.
2. If the antenna is installed the way it is shown in Fig.B or D. to avoid having direct load from coaxial cable,turn a coaxial cable around the balun once and fix with a plastic tape. Set coaxial cable away from the element to avoid causing bad VSWR or unstable VSWR.
3. If the antenna is installed between two trees, to avoid breaking the element by strong wind, it is recommended to put elastic material such as rubber band or coil spring at the both ends of the element.
4. Since antenna adjustment has to be practiced at the place where the antenna is being operated, it is useful to make the antenna up and down easily. It is also useful to get rid of earth effect if the antenna is installed as a horizontal dipole antenna, for the height of the antenna is related with propagation impedance of the antenna.



FIG.A

Three point support

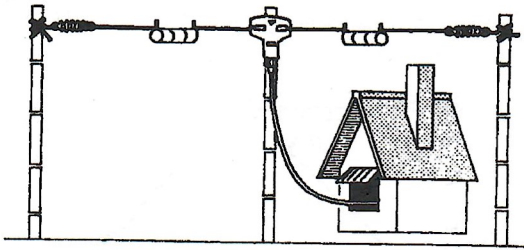

FIG.B

Two point support

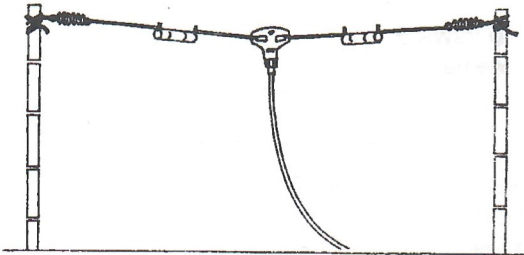

FIG.C

Inverted V  
( $\theta > 120^\circ$ )

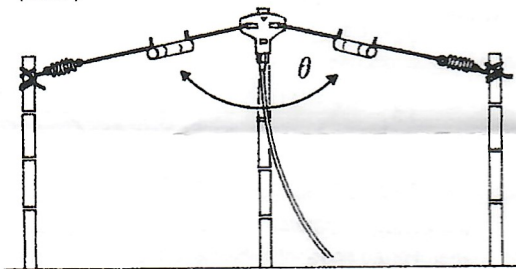

FIG.D

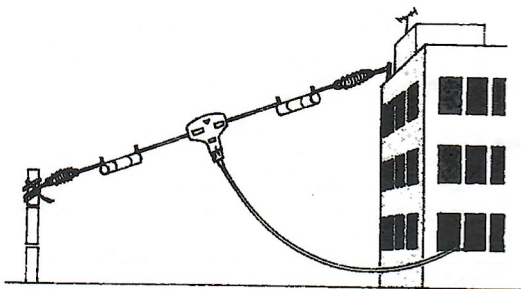
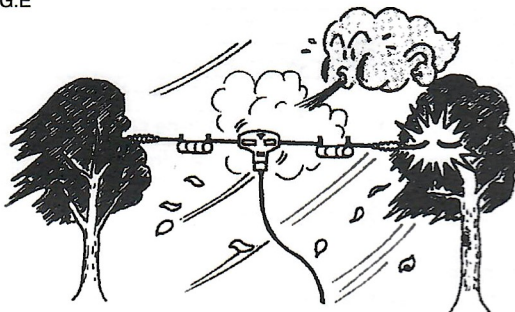

FIG.E



\*Antenna element can be broken off by strong wind.

● Adjustment

1. Prepare a VSWR power meter for applicable frequencies and RF power, and set the meter as shown in the following figure. Practice test transmission for the adjustment as short time and least RF power as possible. (Maximum power rating in constant wave (CW) mode is approximately 1/3 of one in SSB mode.)

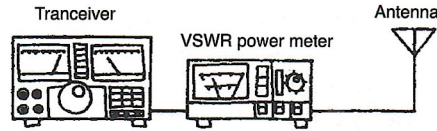

Start adjustment from the highest operating frequency downward by cutting adjustment element, both sides in same length, to desired resonant frequency, least VSWR return at the frequency. Since cutting the element in excess may skip desired frequency and result in losing resonant frequency, cut the element little by little.

\* If VSWR cannot be better.

If VSWR can not be lowered even though resonant frequency came to be desired frequency by cutting the element, it is most likely that the antenna is being effected by earth or near by buildings. Then, it is advised to change antenna height or antenna location. Bending the element downward from the balun can also change VSWR.

● Adjustment element cutting chart

\* Cutting adjustment element will raise resonant frequency.

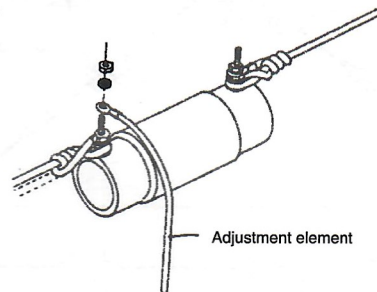

\* The following chart shows resonant frequency change per 1cm element cut.

Frequency	W-8010	W-735	W-721
80m(3.5MHz)	4KHz	4KHz	-
40m( 7MHz)	7KHz	7KHz	8KHz
20m(14MHz)	45KHz	-	-
15m(21MHz)	40KHz	-	50KHz
10m(28MHz)	70KHz	-	-

\* Above values may change depending on surrounding environment.

● Calculating example of element cutting length

\* Since quantity of the frequency change by cutting adjustment element may change more or less depending the place where the antenna is installed, it is recommended to cut the element a bit shorter for adjustment.

Cf. if desired frequency is 7.052MHz at the 40m band and present resonant frequency when the antenna is initially installed is 7.010MHz, VSWR and reflected power is lowest in 7.010MHz:

$$\frac{7.052\text{MHz (desired frequency)} - 7.010\text{MHz (present frequency)}}{42\text{KHz (frequency difference)}}$$

Since frequency change per 1cm at the 40m band is 7KHz from the chart.

$$42(\text{KHz}) \div 7(\text{KHz/cm}) = 6(\text{cm})$$

Since present frequency is lower than desired frequency, cutting the element for 6cm will make resonant frequency to desired 7.052MHz.

● If an antenna has two elements such as W-8010

1. The antenna can be operated with unused band element being removed. In case of the W-8010, however, 80m, 40m and 15m share one element, and 20m, and 10m share another element. therefore, only one of those bands can not be removed.
2. As shown in the following figure, one element dose not have to be installed for the same direction as another element.

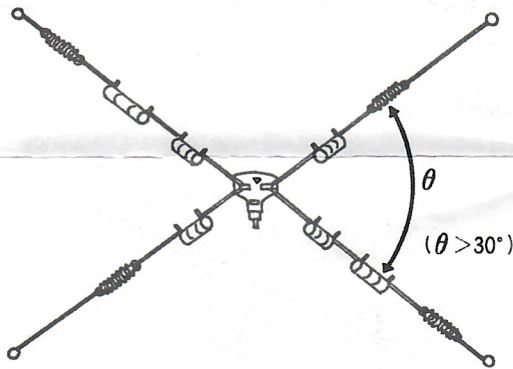

● To add new band

It is possible to add 15m band to the W-735 antenna. As shown in the following figure, installing self-made 15m element to the balun will add 15m band to the antenna.

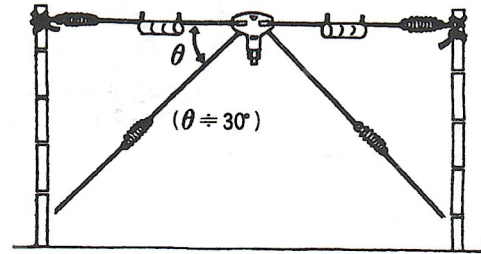

Self-made 15m band element

● VSWR charts

W-8010

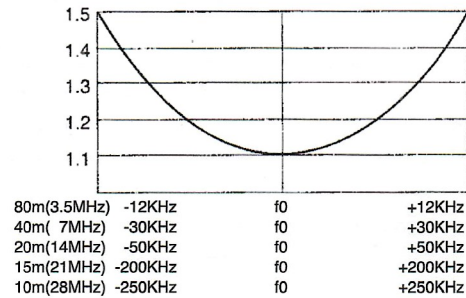

W-735

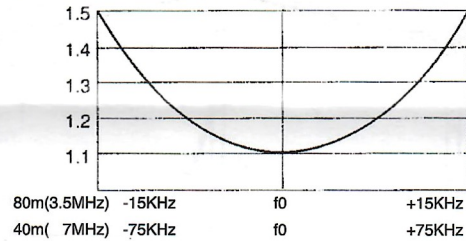

W-721

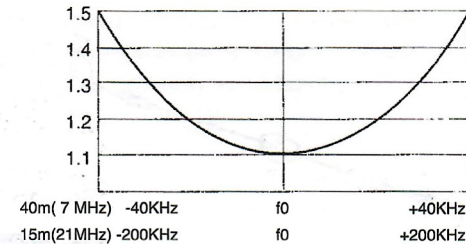

● Specifications

Model	W-8010	W-735	W-721
Frequency	80m/40m/20m/15m/10m (3.5/7/14/21/28MHz)	80m/40m (3.5/7MHz)	40m/15m (7/21MHz)
Impedance	50Ω		
VSWR	Less than 1.5:1		
Max power rating	1.2KW PEP		
Length	19.2m(63.0')	26m(85.3')	12.4m(40.7')
Weight	2.5kgs.(5.50lbs.)	1.85kgs.(4.07lbs.)	1.2kgs.(2.64lbs.)
Type	5 band dipole	2 band dipole	2 band dipole
Connector(BU50A BALUN)	MJ(UHF jack)		

DIAMOND ANTENNA CORPORATION

Miyata Building,15-1,1-chome, Sugamo Toshima-ku, Tokyo 170-002,Japan Phone:(03) 3947-1411 Fax:(03) 3944-2981  
<http://www.diamond-ant.co.jp/english/html> E-MAIL : [overseas@diamond-ant.co.jp](mailto:overseas@diamond-ant.co.jp)