

ACCESSORIES FOR MARINE ANTENNAS

(1 1/4" TPI AS ARE SUITABLE FOR ALL BRANDS OF MARINE AND GPS ANTENNAS)

ELECTROPOLISHED

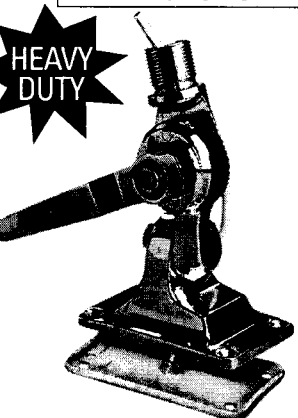

HEAVY DUTY

RA116SS
STAINLESS
STEEL

Ratchet mount polished stainless steel four way for installation on deck or bulkhead, locking by handle. Hole for loran or GPS cable. The exclusive built-in feed-thru allows the passage of coax cable. Standard thread 1" x 14, weight 970 grs.

ELECTROPOLISHED

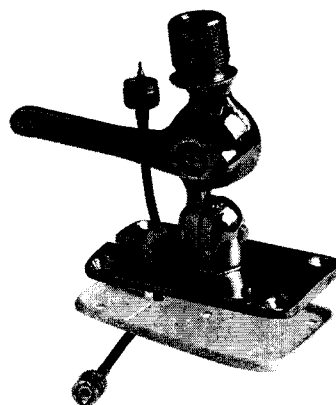

RA166/00
STAINLESS
STEEL

Ratchet mount stainless steel. Four way ratchet mount for installation on deck or bulkhead, locking by knob. Hole for loran or GPS cable. For antennas max 8' in self supporting installation built in feed-thru for coax cable. Standard thread 1" x 14, weight 650 grs.

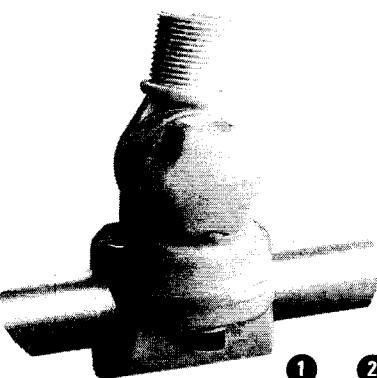

RA134
NYLON

Pulpit rail swivel mount in reinf. nylon with knob hole for GPS cable for pulpits 22 and 25 mm. (7/8" and 1")

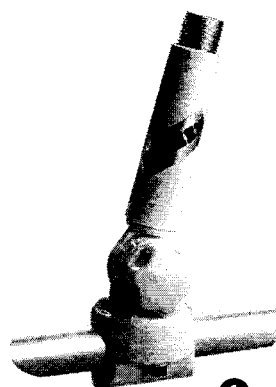
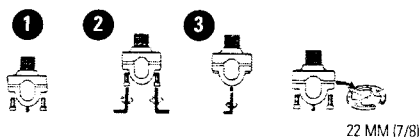

RA147
NYLON

Same as RA134 plus GPS extension 100 mm (4")

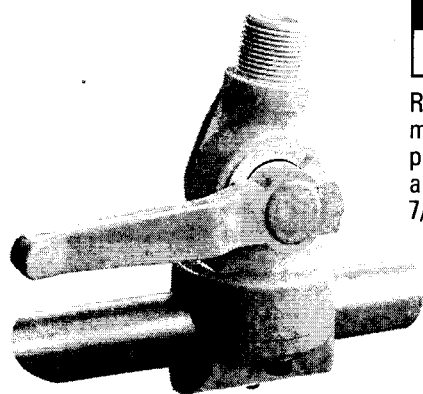
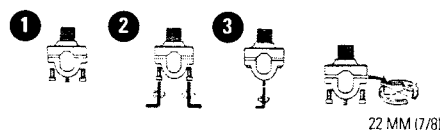

RA125
NYLON

Reinforced nylon pulpit-rail mount 1" x 14 thread predrilled for loran cable adaptable for tubes 1" or 7/8" (22 or 25 mm)

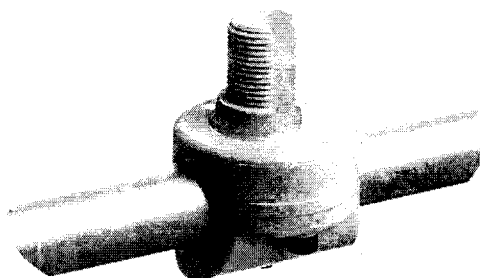
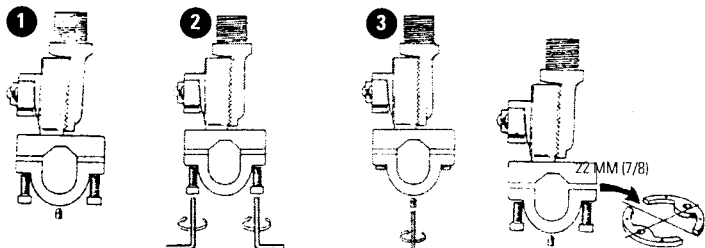

RA145
NYLON

Reinforced nylon pulpit-rail mount 1" x 14 thread for GPS antennas only.

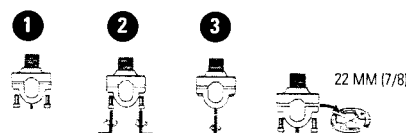

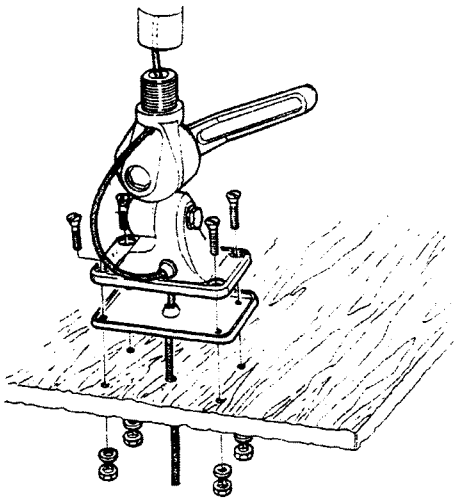

RA115
NYLON

4 way ratchet mount. 8 mm Hole for Ioran or GPS cable feed thru for coax cable and gasket, standard thread 1" x 14 for antennas max 8' (2,40 mts), weight 200 grs.

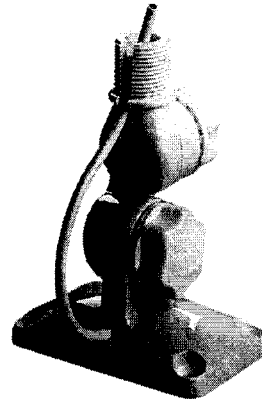

RA135
NYLON

Four way ratchet mount for installation on deck or bulkhead, locking by knob. Hole for Ioran or GPS cable. For antennas max 8' in self supporting installation built in feed-thru for coax cable. Standard thread 1" x 14, weight 140 grs.

ELECTROPOLISHED

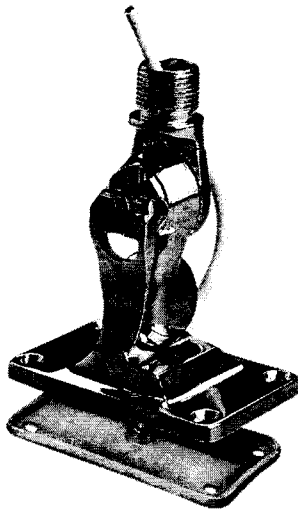

RA107SS
STAINLESS STEEL

Ratchet mount polished stainless steel four way for installation on deck or bulkhead, locking by clamp. Hole for Ioran or GPS cable. The exclusive built in feed-thru allow the passage of coax cable. Standard thread 1" x 14, weight 600 grs.

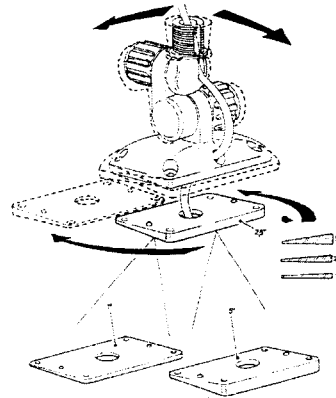

RA101
NYLON

Set of 3 rectangular wedges for Glomex ratchet mount allows to keep the antenna vertical on the inclined surfaces.

ELECTROPOLISHED

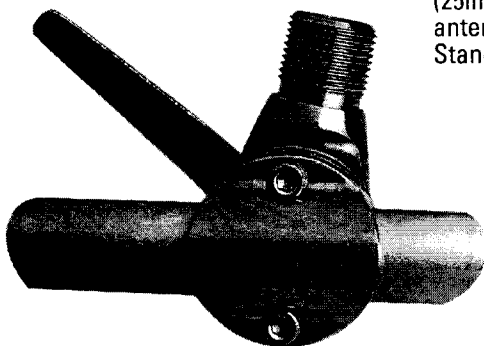

RA165
STAINLESS STEEL

Rail ratchet mount stainless steel. Ratchet design with hole for Ioran or GPS cable. Vertical or horizontal installation on rails of 7/8" (22mm) and 1" (25mm). Designed for antennas up to eight feet. Standard thread 1" x 14.

RA175
NYLON

Rail mount reinforced nylon UV resistant. For installation of GPS antennas only on horizontal rail of 22 mm (7/8"), 25 mm (1"), and 30 mm. Supplied with clamps for all 3 rail diameters.

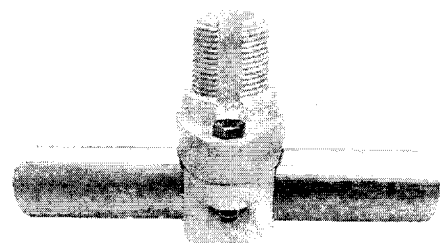
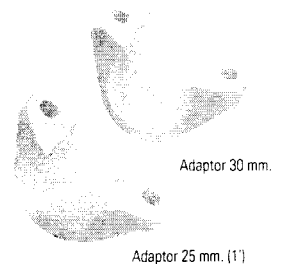

ELECTROPOLISHED

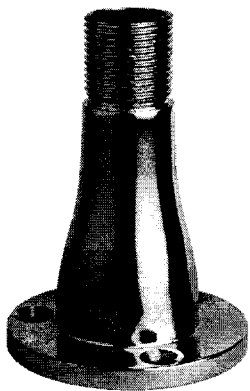

V9174
STAINLESS
STEEL

Universal mount stainless steel standard thread 1" x 14 height 100 mm (4"), weight 280 grs.

V9175
NYLON



Universal mount reinforced nylon. For GPS antenna standard thread 1" x 14 height 100 mm (4").

28 (1" 1/4) 25 (1")

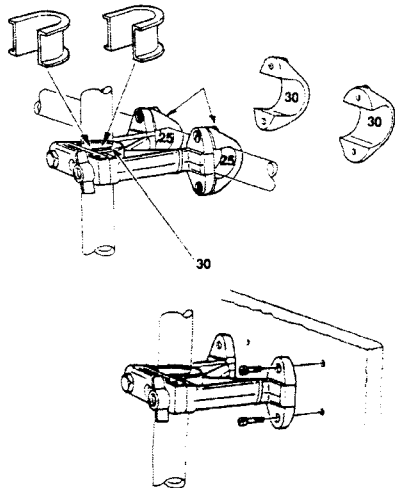

RA119
NYLON

Stand-off bracket reinforced nylon. Insulated stand-off bracket for bulhead and rail of Ø 25 mm (1") and 30 mm. Accepts Ø 38,5 mm. (1,5") antennas and its supplied with inserts for extensions diam. 25 mm (1"), 28 mm (1" 1/4) and 30 mm.

ELECTROPOLISHED

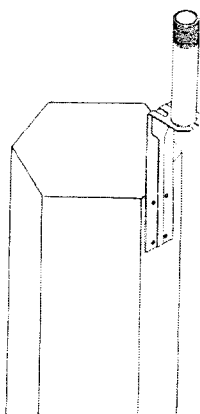

V9176
STAINLESS
STEEL

L Masthead bracket in electropolished stainless steel height 200 mm (8"). standard thread 1" x 14.

ELECTROPOLIS

V9171
STAINLESS
STEEL

Pipe mounting bracket in stainless steel, thread 1" x 14. For horizontal and vertical mount on tubes diam. 25-80 mm, weigert 600 grs.

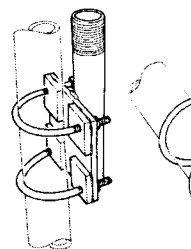

STAINLESS STEEL EXTENSIONS

RA103/15 150 mm (6")

RA103/30 300 mm (1')

RA103/60 600 mm (2')

RA123 1,5 mts (5')

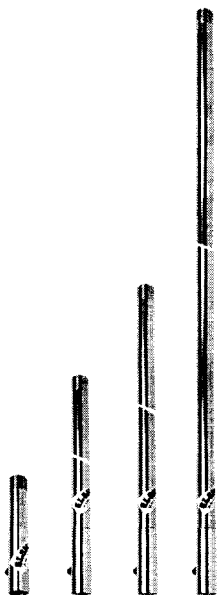

FIBREGLASS EXTENSIONS

RA122/60 0,6 mts (2')

RA149 1,20 mts (4')

RA120 2 mts (6'8")

RA150 2,40 mts (8')

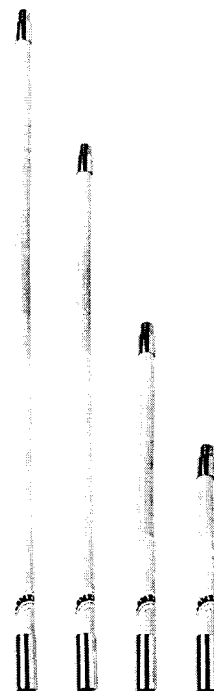

GPS
IN AI

RA

RA

RA

RA

RA



Via Faentina, 156/G - 48100 Ravenna - Italy
Tel. +39 544 500377 - Fax +39 544 500420
e-mail: info@glomex.it

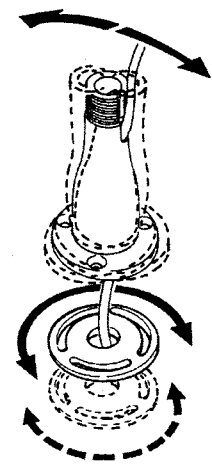

RA102
NYLON

Set of 2 round wedges for Glomex universal mounts V 9175 - V 9174 and V 9124 allow to keep the antenna vertical on the inclined surfaces.

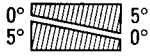

V9101

PVC gasket for alluminium surface insulation for V 9174 - V 9124

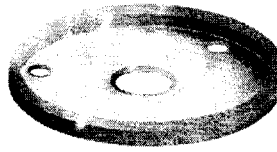

RA138
PVC

PVC threaded protection for all size PL259 connectors.

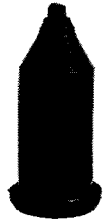

IED

ELECTROPOLISHED

V9173
STAINLESS
STEEL

Masthead bracket in electropolished stainless steel Standard thread 1"x 14, weight 330 grs.

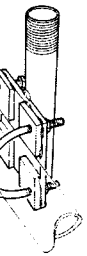
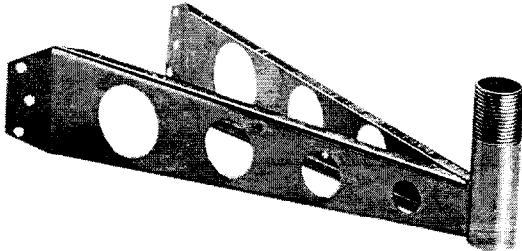

RA140
NYLON

Nylon feed-thru for deck passage of one or two coaxial cables and connectors (RG58 or similar).

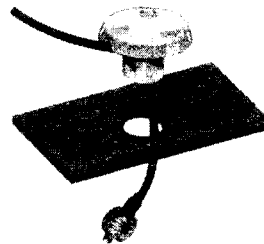

RA139
NYLON

Four way nylon swivel base for plotters.

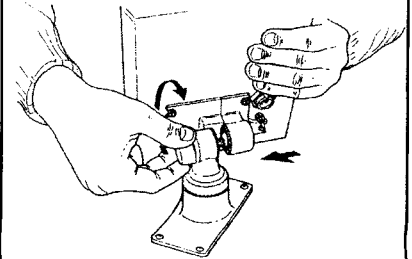

EXTENSIONS
ALUMINIUM EPOXY COATED

- 29/15** 0,15 mts (6")
- 29/30** 0,3 mts (1')
- 29/60** 0,6 mts (2')
- 29/120** 1,20 mts (4')

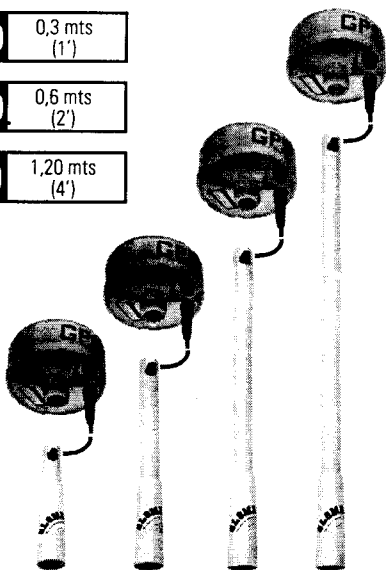

RA136
NYLON

Kit for installation of electronic chart plotters allows installation of the plotters on a vertical tube diam. 25 mm (1") and 22 mm (7/8"). The plotter can be adjusted on the vertical and horizontal axis, when not used the mount can be folded by the swivel rail mount installed on the vertical tube.

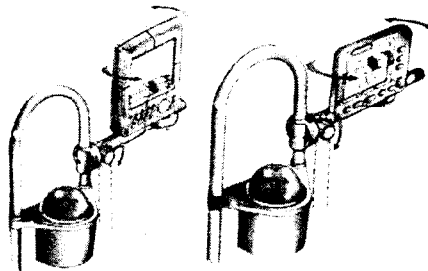

RA137
NYLON

Kit for installation of electronic chart plotters allows installation of the plotters on a horizontal tube diam. 25 mm (1") and 22 mm (7/8"). The plotter can be adjusted on the horizontal axis by the ratchet lock up.

