

TECSUN

S-2200x

FM STEREO / LW / MW / SW • SSB / AIRBAND

OPERATION MANUAL

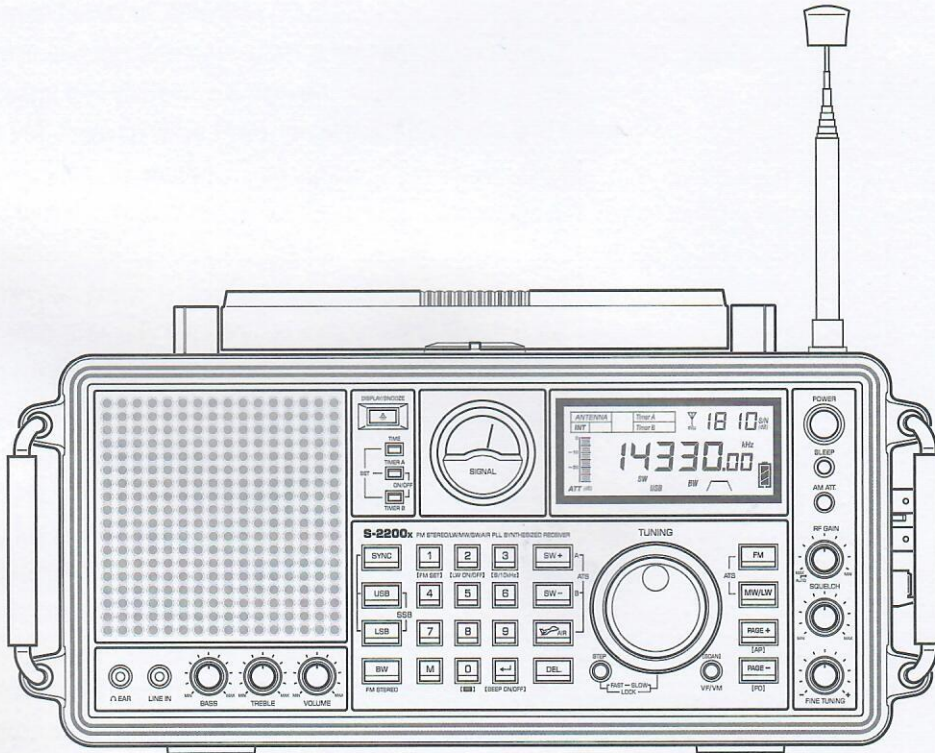

TECSUN ELECTRONIC IND. LTD.

CONTENTS

GETTING STARTED

Important (safety) considerations	1
S-2200x at a glance	2
Powering your S-2200x	6
Using 4 D batteries	6
Using 2 18650 batteries	6
Charging the 18650 batteries	7
Lithium battery safety instructions	7
Setting up your S-2200x	8
Setting the clock (24-hour format)	8
Setting the FM frequency range	8
Setting the MW tuning step and AM (MW/LW/SW) frequency range	8
Enabling / Disabling longwave (LW)	8

USING YOUR S-2200x

Turning the radio on / off	9
Volume control	9
Using internal / external antennas	9
Longwave and medium wave (AM) antennas	9
FM, airband and shortwave antennas	10
Selecting FM, medium wave (AM), longwave, shortwave and airband	12
Tuning in stations (VF mode)	12
Manual tuning	13
Auto scan	13
Direct keypad entry	13
Storing frequencies into memory	14
Storing frequencies manually	15
Storing frequencies during auto scan	16
Auto tuning storage (ATS)	16
Optimizing ATS frequency storage results	17
Setting the signal capture sensitivity of Auto Tuning Storage (ATS)	18
Auto sorting memory	18
Listening to stored frequencies (VM mode)	19
Recalling stored frequencies manually	19
Recalling stored frequencies by scanning a memory page	19
Deleting frequencies from memory	20
Deleting a single frequency	20
Deleting frequencies during memory page scan	20
Deleting all stored frequencies in a memory page	20
Deleting all stored frequencies from memory	20

Auto Paging (AP) mode: Time-specific memories for MW (AM) and SW	21
Using AP ATS to create time-specific memories for MW (AM) and SW	21
Optimizing ATS frequency storage results in Auto Paging (AP) mode	22
Setting the signal capture sensitivity of AP ATS	22
AP manual storage	22
Recalling AP time-specific MW (AM) and SW memories	23
Antenna signal attenuation	24
RF gain control	24
Squelch control	24
SSB (Single Sideband) tuning	25
Synchronous detection (SYNC)	25
AM bandwidth selection	25
FM de-emphasis time constant	26
FM stereo/mono selection	26
Treble & bass control	26
Setting the sleep timer	26
Add seconds to the clock	26
Activating / deactivating the alarm	26
Setting the alarm time	27
Setting a radio frequency for the alarm	27
Alarm auto clearance	27
Alarm snooze function	28
Using headphones	28
Audio input (line in)	28
Audio output (line out)	28
Display options	29
Display backlight	29
Activate / deactivate 'BEEP' sound	29
Keylock	29
 MISCELLANEOUS	
Troubleshooting	30
S-2200x specifications	31

GETTING

Read this user

WARNING

- Keep it dry. I corrosion to wait for the r
- Do not place span of certa
- Do not place temperature
- Clean only w
- Unplug and
- Do not attem
- Refer servic

(LITHIUM) BA

- Improper rep the same typ batteries with
- Do not charg
- Do not expos pressure.
- Dispose of a
- Do not short-use it.
- If not using fr use non-con performance
- Please cons checked lug

ENVIRON



GETTING STARTED - Important (Safety) Considerations

Read this user manual carefully before use and save it for future reference.

WARNING

- Keep it dry. Rain, humidity and other types of liquids or moisture can contain minerals that may cause corrosion to components. If the device does accidentally get wet, remove the batteries immediately and wait for the radio to dry completely before placing them back.
- Do not place or store the device in environments above +45°C. High temperatures can shorten the life span of certain components.
- Do not place or store the device in cold environments below -5°C. Otherwise, once the surrounding temperature rises, internal condensation may develop and damage the circuit board and LCD display.
- Clean only with a dry cloth. Do not use detergents or chemical solvents as this might damage the finish.
- Unplug and disconnect external antennas (not included) during lightning storms.
- Do not attempt to disassemble the device to adjust internal parameters.
- Refer servicing to qualified service personnel.

(LITHIUM) BATTERY SAFETY INSTRUCTIONS

- Improper replacement of a lithium battery may result in an explosion. Replace only with a lithium battery of the same type or equivalent (the lithium batteries used in this device are 18650 rechargeable Li-ion batteries with a protection circuit).
- Do not charge non-rechargeable batteries.
- Do not expose the batteries to heat sources (e.g. sunlight, fire), low temperatures, humidity, or high pressure.
- Dispose of a battery properly and prevent children from playing with electric currents.
- Do not short-circuit or disassemble a battery. If a battery is seriously inflated, please do not continue to use it.
- If not using for an extended period of time, remove the batteries and store them in a safe manner. Please use non-conductive material to wrap a battery in order to avoid direct contact with metal. You can avoid performance loss by keeping the batteries in a cool and dry place.
- Please consciously abide by aviation regulations; lithium batteries are often prohibited from placing into checked luggage.

ENVIRONMENT



Disposal



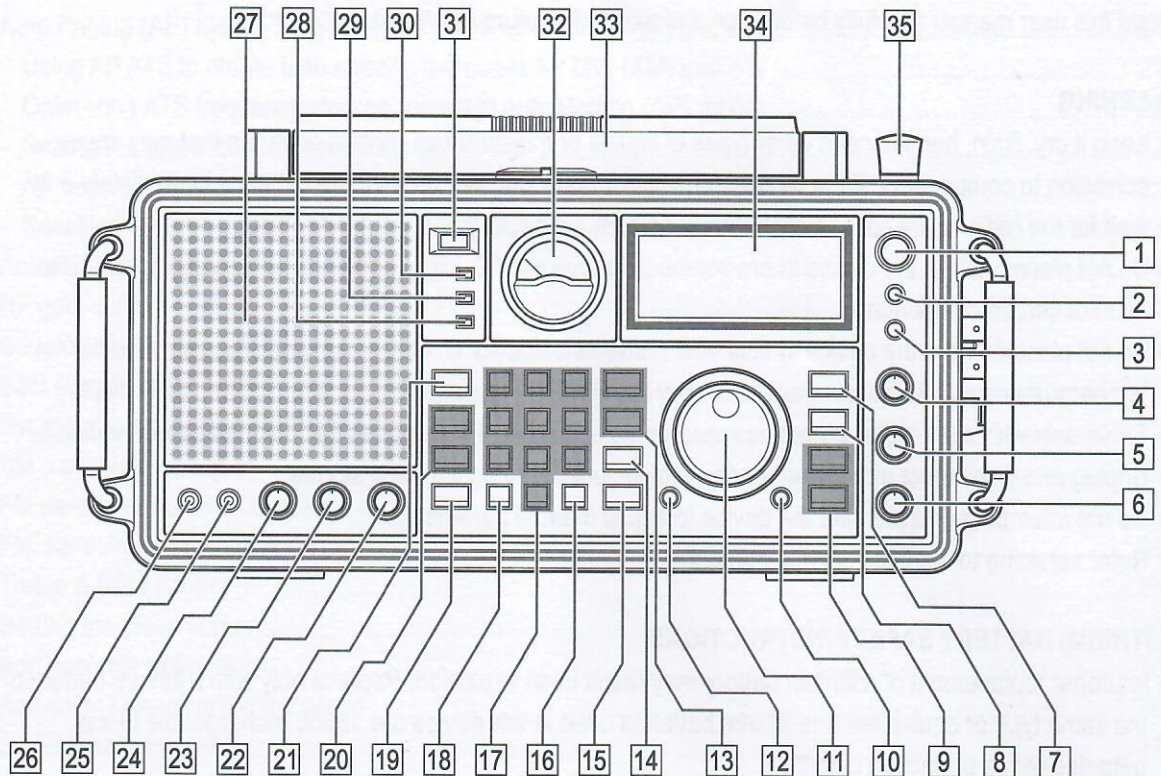

If at any time in the future you should need to dispose of this product, please note that: Waste electrical products should not be disposed off with household waste. Please recycle where facilities exist. Check with your Local Authority or retailer for recycling advice. (Waste Electrical and Electronic Equipment Directive)

Getting Started: S-2200x at a Glance



- 1 POWER: Power button
- 2 SLEEP: Sleep timer setting to auto turn off after a defined length of time.
- 3 AM ATT. : Antenna signal attenuation for LW, MW, and shortwave.
- 4 RF GAIN: Radio frequency gain control for LW, MW, and shortwave.
- 5 SQUELCH: Squelch control for LW, MW, shortwave, and airband.
- 6 FINE TUNING: Fine tuning adjustment of the frequency.
- 7 FM: FM band / Auto tune and store FM frequencies (ATS).
- 8 MW/LW: MW (AM) and LW bands / Auto tune and store LW/MW frequencies (ATS).
- 9 PAGE + / AP, PAGE - / P0: Select memory page / Auto Paging (AP) mode / Quick select P0.
- 10 VF/VM, SCAN:
 - Switch between frequency tuning (VF) and memory (VM) modes.
 - Auto scan a frequency band or memory page.
- 11 TUNING: Main tuning knob.
- 12 STEP FAST-SLOW, LOCK: Adjust the tuning speed of the main knob / (Un)lock the functions of the buttons, main and fine tuning knob.
- 13 SW +, SW - : Shortwave band / Change SW meter band / Auto tune and store SW frequencies (ATS).
- 14  AIR : Airband / Auto tune and store airband frequencies (ATS).

Getting Started: S-2200x at a Glance (continued)

- 15 DEL. : Delete frequencies stored into memory.
- 16  /BEEP ON/OFF: Confirm button / Activate or deactivate the beeping sound after a button press.
- 17 0-9: Numeric keys to input a frequency, a memory location, set the clock or an alarm.
Additionally,
 - [1] FM SET: Set the FM frequency range (in power off mode).
 - [2] LW ON/OFF: Enable/Disable the longwave (LW) band (in power off mode).
 - [3] 9kHz/10kHz: Set the medium wave (AM) tuning step and frequency range (in power off mode).
 - [4] Set FM de-emphasis time constant (while listening to FM).
 - [5] Set the signal capture sensitivity of ATS in Auto Paging (AP) mode.
 - [8] Display/Hide seconds on the clock (in power off mode).
 - [0]  : Auto Sorting Memory: Organizes frequencies stored into the memory (in power off mode).
- 18 M: Store frequencies into memory.
- 19 BW / FM STEREO: Adjust the AM bandwidth / Select FM stereo or mono mode / Adjust the signal capture sensitivity of Auto Tuning Storage (ATS).
- 20 SSB: Enable/Disable Single Sideband mode (USB: Upper Sideband / LSB: Lower Sideband).
- 21 SYNC: Enable/Disable synchronous detection.
- 22 VOLUME: Volume adjustment knob
- 23 TREBLE: Treble adjustment knob
- 24 BASS: Bass adjustment knob
- 25 LINE IN: Audio input socket ($\Phi 3.5$ mm)
- 26  EAR: Stereo headphone socket ($\Phi 3.5$ mm)
- 27 Speaker
- 28 TIMER B: Set, enable/disable alarm B.
- 29 TIMER A: Set, enable/disable alarm A.
- 30 TIME: Set and display the clock.
- 31  , DISPLAY/SNOOZE: Backlight switch / Display mode / Enable/Disable alarm snooze function.
- 32 SIGNAL: Signal strength indicator
- 33 LW/MW ROTATABLE ANTENNA: Rotatable longwave / medium wave (AM) magnetic rod antenna
- 34 LCD screen
- 35 Whip antenna (for shortwave / FM / airband)

Getting Started: S-2200x at a Glance (continued)

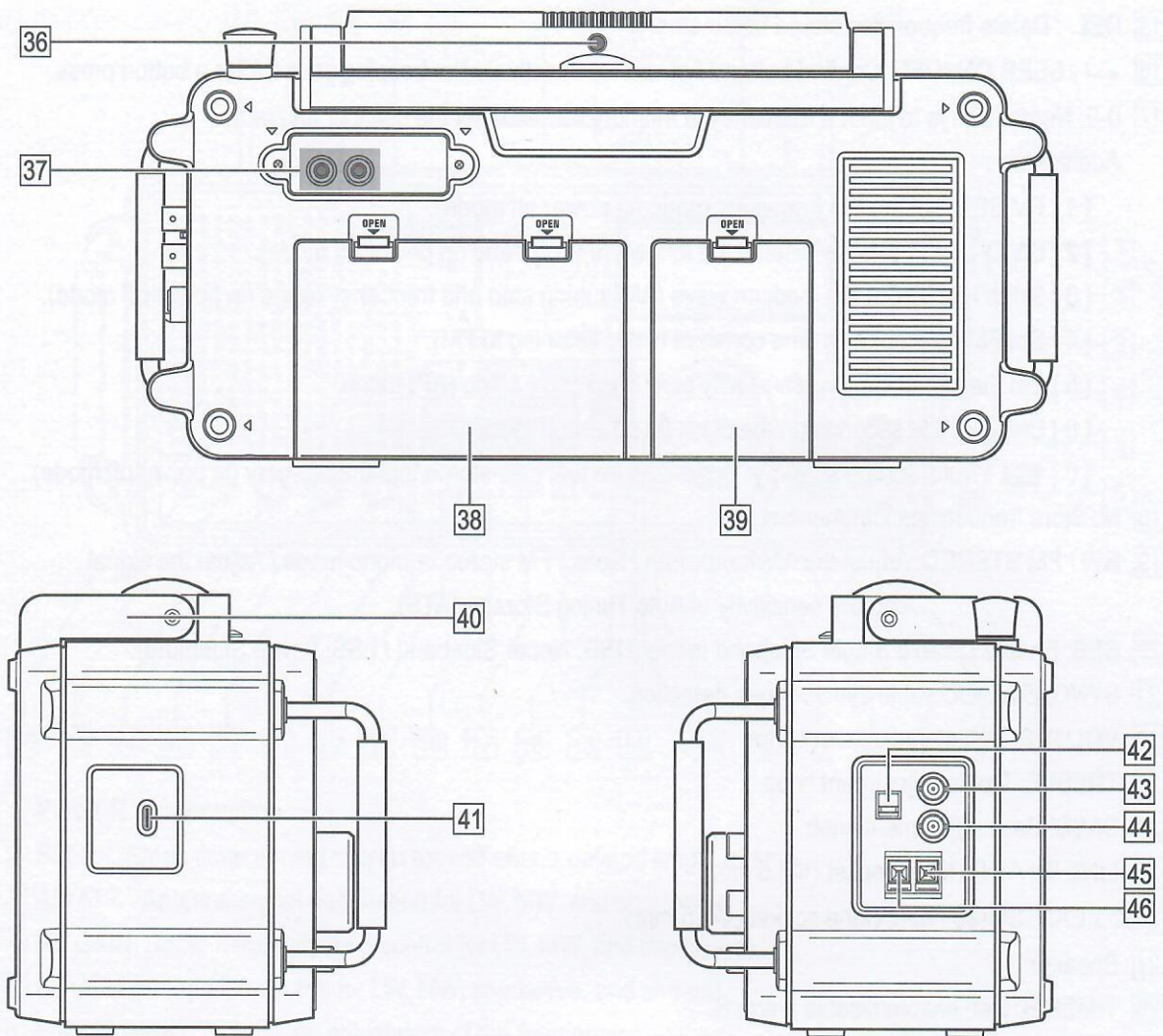

- 36 LW/MW ANTENNA INPUT: Longwave/Medium wave external antenna socket ($\Phi 3.5$ mm).
- 37 LINE OUT: Stereo audio output socket (RCA)
- 38 6V battery compartment. Insert 4 D-type (R20/UM1) 1.5V batteries.
- 39 8.4V battery compartment. Insert 2 18650 type 4.2V (nominal 3.7V) lithium batteries.
- 40 Retractable carry handle
- 41 DC 5V 2A: USB-C socket. DC input is only used for charging the 2 18650 lithium batteries.
- 42 INT. ANT. / EXT. ANT.: Switch between the telescopic antenna (SW/FM/AIR) and an external antenna.
- 43 FM/AIR ANT.: FM/Airband antenna socket (BNC)
- 44 SW ANT.: Low-impedance shortwave antenna socket (BNC)
- 45 SW ANT.: High-impedance shortwave antenna socket (red), used in conjunction with the ground socket.
- 46 GND: Ground socket (black)

Getting Started: S-2200x at a Glance - Display Indication

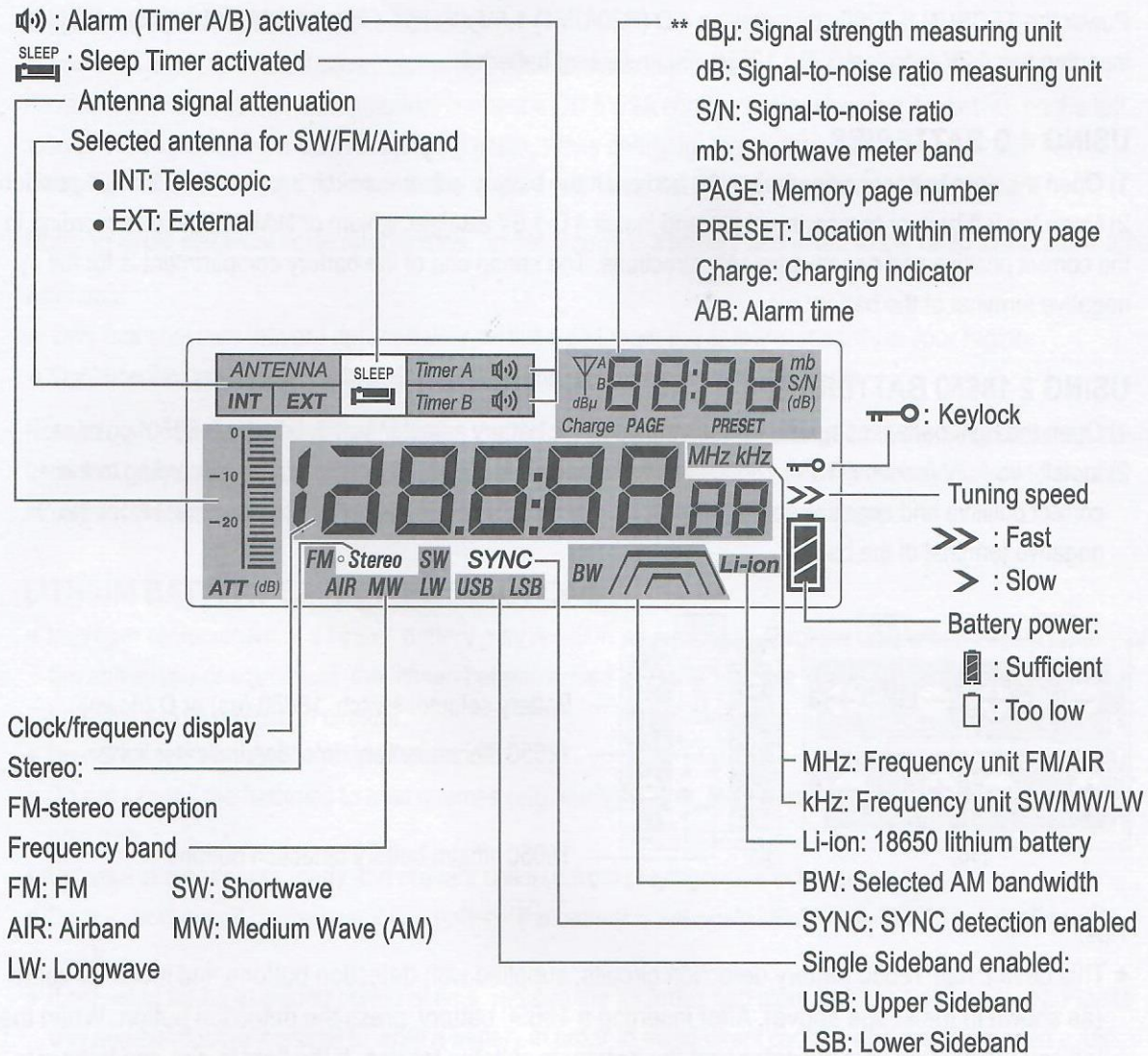

** Display indication examples:

Signal strength / S/N ratio: ∇ **24 18** ^{S/N} _(dB) (signal strength: 24dBμ / S/N ratio: 18dB)

Shortwave meter band: **19**^{mb} Clock time: **20:18**

Location within memory page: **232**
PRESET Alarm clock (Timer A): **6:30**^A

Organizing memory in progress: **POC3** Alarm clock (Timer B): **15:30**^B

Getting Started - Powering Your S-2200x

Power the TECSUN S-2200x by installing 4 D (R20/UM1) 1.5V alkaline, lithium or NiMH batteries, or by inserting two 4.2V (nominal 3.7V) 18650 lithium (Li-ion) batteries.

USING 4 D BATTERIES

- 1) Open the right battery compartment [39] and push the battery selector switch into the "R20 Size D" position.
- 2) Open the left battery compartment [38] and install 4 D 1.5V alkaline, lithium or NiMH batteries according to the correct positive and negative polarity directions. The spring end of the battery compartment is for the negative terminal of the battery.

USING 2 18650 BATTERIES

- 1) Open the right battery compartment [39] and push the battery selector switch into the "18650" position.
- 2) Install two 4.2V (nominal 3.7V) 18650 lithium batteries into the battery compartment according to the correct positive and negative polarity directions. The spring end of the battery compartment is for the negative terminal of the battery.

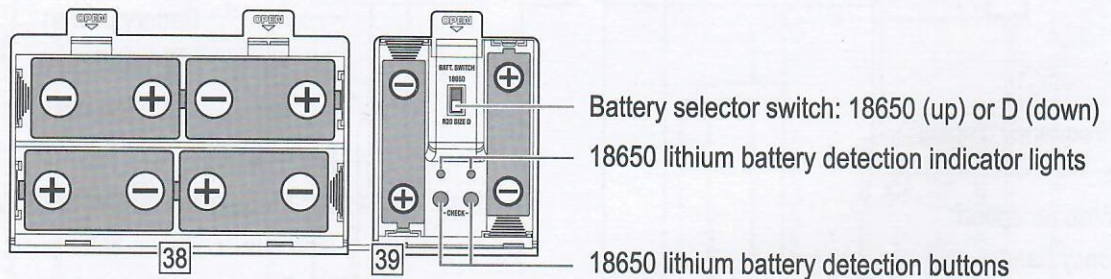

Tips:

- This device has 18650 battery detection circuits, supplied with detection buttons and indicator lights (as shown in the image above). After inserting a 18650 battery, press the detection button. When the indicator light is on, this indicates that the battery is suitable for use. If the light is dim, the battery is low on power and should be charged. If the light is off, the battery is depleted or damaged.
- When battery power is sufficient, the display shows the battery level as:
- When the battery is almost exhausted, the display shows the battery level as:
- If the radio will not be used for an extended period of time, please remove the batteries.

CHARGING THE 18650 BATTERIES

When the battery icon is displayed as “”, this indicates that battery power is about to run out.

To recharge the 18650 lithium batteries, connect a DC 5V/2A charger to the charging socket  on the left side of the device using a USB-C charging cable. While charging, the charging time is shown and the charging indicator “Charge” flashes on the display and stops flashing once charging is complete.

Note: To avoid electrical noise interference, do not charge the battery and listen to the radio at the same time.

Attention!

- Only use chargers that are appropriately certified and meet the safety standards in your region.
- Only use lithium batteries with built-in charge and discharge protection circuits.

Notes: In order to extend battery life, when the lithium batteries are fully charged but the device has not been used for 6 days, the device enters into a self-discharge state. When the batteries are discharged to a safe storage state (the remaining power is about 70%), the regulated self-discharge stops.

LITHIUM BATTERY SAFETY INSTRUCTIONS

- Improper replacement of a lithium battery may result in an explosion. Replace only with a lithium battery of the same type or equivalent (the lithium batteries used in this device are 18650 rechargeable Li-ion batteries with a protection circuit).
- Do not charge non-rechargeable batteries.
- Do not expose the batteries to heat sources (e.g. sunlight, fire), low temperatures, humidity, or high pressure.
- Dispose of a battery properly and prevent children from playing with electric currents.
- Do not short-circuit or disassemble a battery. If a battery is seriously inflated, please do not continue to use it.
- If not using for an extended period of time, remove the batteries and store them in a safe manner. Please use non-conductive material to wrap a battery in order to avoid direct contact with metal. You can avoid performance loss by keeping the batteries in a cool and dry place.
- Please consciously abide by aviation regulations; lithium batteries are often prohibited from placing into checked luggage.

Getting Started - Setting up your S-2200x

SETTING THE CLOCK (24-HOUR FORMAT)

- 1) Press and hold the [TIME] button **[30]** until the hours indicator starts flashing.
- 2) Use the numeric keys to enter the current time (hours + minutes is four digits). Alternatively, rotate the [TUNING] knob **[11]** to adjust the hours, then quick press [TIME] to confirm. Then adjust the minutes, followed by a quick press of the [TIME] button to confirm the setting.

Tip: With the device on, quick press [TIME] to display the current time. Quick press [TIME] again to return to the radio frequency display.

SETTING THE FM FREQUENCY RANGE

Set the frequency range to correspond with the country in which to use the radio.

- 1) Turn the device off.
- 2) Press and hold the [1] (FM SET) button, and then turn the main tuning knob **[11]**. The display will show "64", "76", "87" or "88" to indicate the corresponding range: 64 - 108MHz, 76 - 108MHz, 87 - 108MHz or 87.5 - 108MHz. Instead of rotating the knob to select the FM range, you can also press [1] repeatedly.
- 3) Quick press [←] **[16]** to confirm the FM range, or wait for 2 seconds for the system to auto confirm.

SETTING THE MW TUNING STEP AND AM (MW/LW/SW) FREQUENCY RANGE

With the device off, press and hold the [3] (9/10kHz) button to set the tuning step and frequency range of MW that corresponds with the country in which to use the radio.

Display indicates "9":

- MW tuning steps are set to 9 kHz.
- MW frequency range is 522 - 1620 kHz (for Europe, Africa, Asia, Oceania).
- LW frequency range is 50 - 522 kHz.
- SW frequency range is 1621 - 29999 kHz.

Display indicates "10":

- MW tuning steps are set to 10 kHz.
- MW frequency range is 520 - 1710 kHz (for North and South America).
- LW frequency range is 100 - 519 kHz.
- SW frequency range is 1711 - 29999 kHz.

ENABLING/DISABLING LONGWAVE (LW)

With the device off, press and hold the [2] (LW ON/OFF) button, the display shows "On" (enabled) or "OFF" (disabled). To select the LW frequency band, power on the device and then quick press the [MW/LW] button to select the LW frequency band (press twice if necessary).

Using Your S-2200x

TURNING THE RADIO ON / OFF

Quick press the red [POWER] button **1** to turn it on and off.

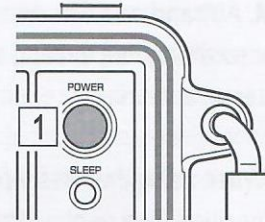

VOLUME CONTROL

Rotate the [VOLUME] knob **22** clockwise or counterclockwise to select your desired volume level.



USING INTERNAL / EXTERNAL ANTENNAS

Warning! Outdoor antennas require protection measures!

- An outdoor antenna must be kept away from power lines! It must be windproof, waterproof, and requires protection from lightning strikes.
- Do not use gas pipes for grounding purposes.
- Do not use water pipes as ground wires for lightning protecting.
- During a thunderstorm, do not use an outdoor antenna! Disconnect the outdoor antenna from the radio.

Longwave and Medium Wave (AM) antennas

When listening to longwave or medium wave broadcasts, rotating the LW/MW ROTATABLE ANTENNA on top of the S-2200x can improve the reception. An external antenna can also be plugged into the "LW/MW ANTENNA INPUT" socket ($\phi 3.5$ mm) **36** of the rotatable antenna (this will disconnect the receiving function of the rotatable antenna).

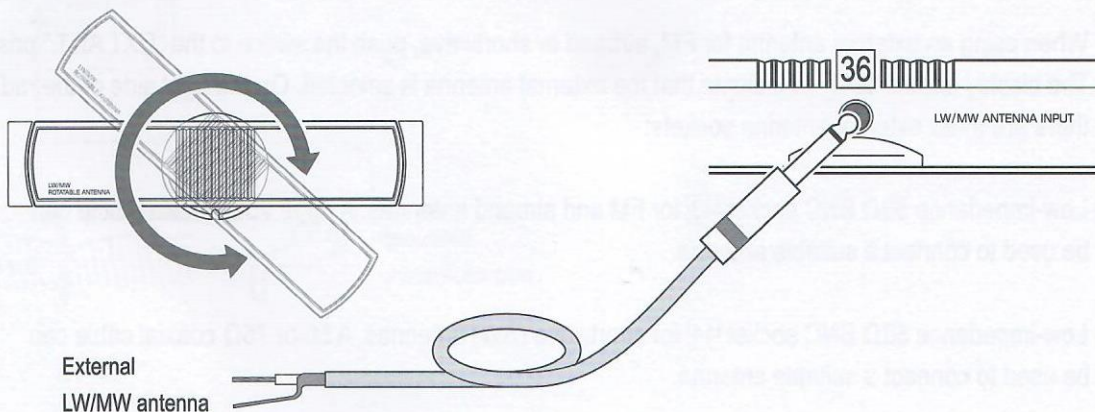

FM, Airband and Shortwave Antennas

For receiving FM, airband and shortwave broadcasts, you can either use the telescopic antenna or an external antenna.

- When using the telescopic (internal) antenna, push the [INT ANT. / EXT ANT.] switch **42** to the “INT ANT.” position. The display shows “INT” to indicate that the telescopic antenna is selected. Changing the length and angle of the telescopic antenna can improve the reception.

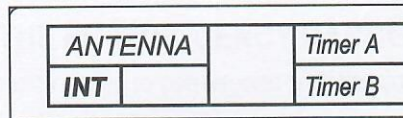

Internal (telescopic) antenna selected

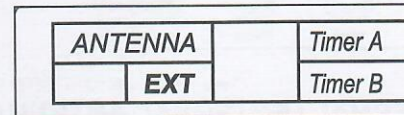

External antenna selected

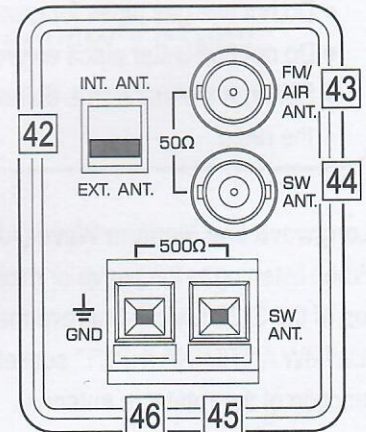
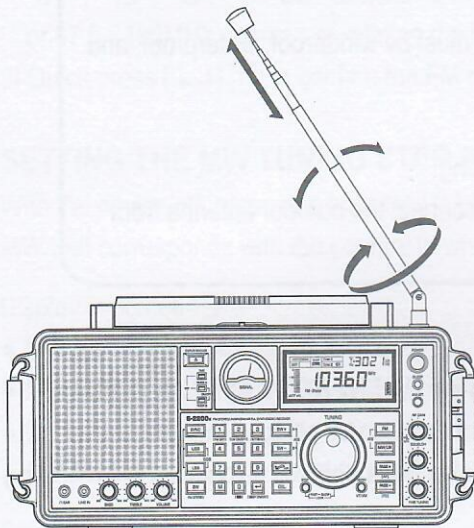

- When using an external antenna for FM, airband or shortwave, push the switch to the “EXT ANT.” position. The display shows “EXT” to indicate that the external antenna is selected. On the right side of the radio, there are three external antenna sockets:

- 1) Low-impedance 50Ω BNC socket **43** for FM and airband antennas. A 50 or 75Ω coaxial cable can be used to connect a suitable antenna.
- 2) Low-impedance 50Ω BNC socket **44** for shortwave (SW) antennas. A 50 or 75Ω coaxial cable can be used to connect a suitable antenna.

3) High-impedance 500Ω black and red spring terminals for shortwave (SW) antennas. These sockets can be used with (for example) a long wire antenna. Take around 10-35 meters (30-100 feet) of wire and plug it into the red "SW ANT." socket [45](#). Position the wire above ground and make sure that it runs in a straight line as much as possible. The wire should not touch any other metal objects. If you do this indoors, position the wire as close to windows as possible. Then, plug a 10-20 meter (30-60 feet) wire into the black "GND" socket [46](#) and let it run on the floor/ground. Alternatively, connect the black spring terminal to a cold water pipe with as short a piece of wire as possible.

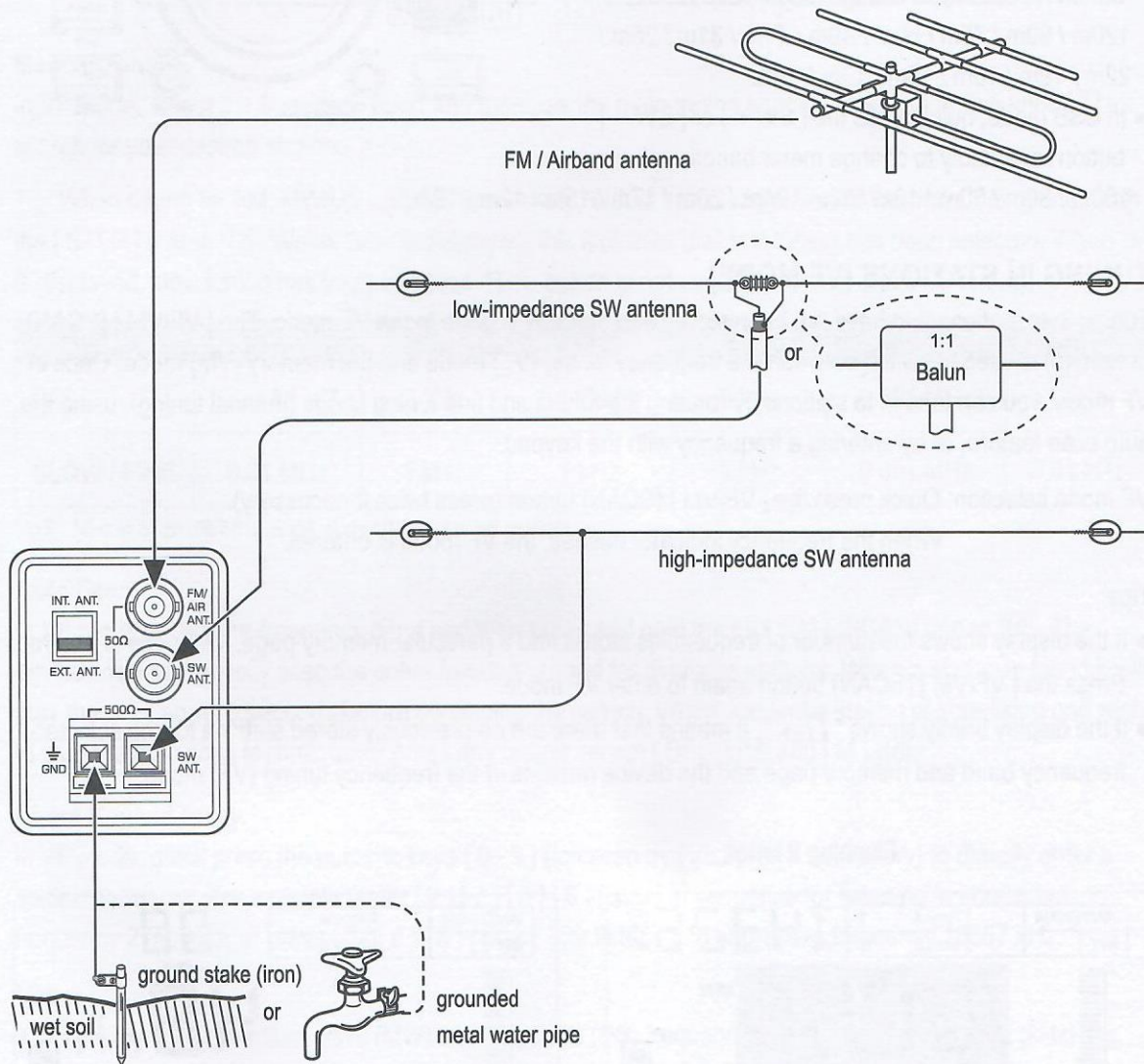

SELECTING FM, MEDIUM WAVE (AM), LONGWAVE, SHORTWAVE AND AIRBAND

FM: Quick press the [FM] button **7** .

Medium Wave / Longwave: Quick press the [MW/LW] button (press it twice if necessary) **8** .

Shortwave: Quick press the [SW +] or [SW -] button **13** .

Airband: Quick press the [AIR] button **14** .

Tips:

- In the SW band, quick press the [SW +] or [SW -] button repeatedly to change meter bands:
120m / 90m / 75m / 60m / 49m / 41m / 31m / 25m / 22m / 19m / 16m / 15m / 13m / 11m.
- In SSB mode, quick press the [SW +] or [SW -] button repeatedly to change meter bands:
160m / 80m / 60m / 40m / 30m / 24m / 20m / 17m / 15m / 12m / 10m.

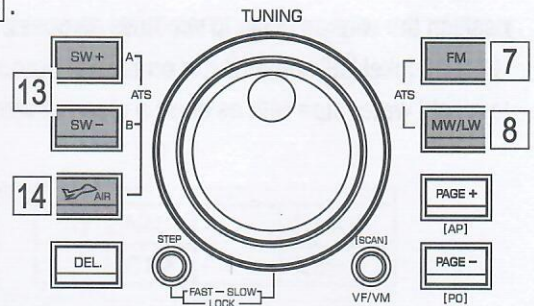

TUNING IN STATIONS (VF MODE)

Tuning in to stations that have not been stored into memory is done in the VF mode. The [VF/VM] (SCAN) button **10** is used to switch between the frequency tuning (VF) mode and the memory (VM) mode. Once in VF mode, you can tune in to stations by rotating the tuning and fine tuning knobs (manual tuning), using the auto scan feature, or by entering a frequency with the keypad.

VF mode selection: Quick press the [VF/VM] (SCAN) button (press twice if necessary).

When the frequency indicator flashes, the VF mode is entered.

Tips:

- If the display shows the number of frequencies stored into a particular memory page, VM mode is entered. Press the [VF/VM] (SCAN) button again to enter VF mode.
- If the display briefly shows " \square_{ch} ", it means that there are no previously stored stations for the selected frequency band and memory page and the device remains in the frequency tuning (VF) mode.

Flashing 2 times

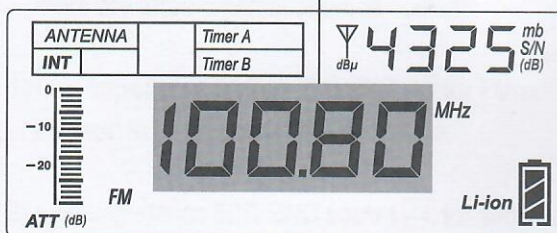

VF mode

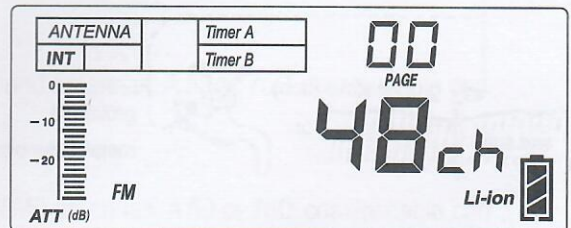

VM mode

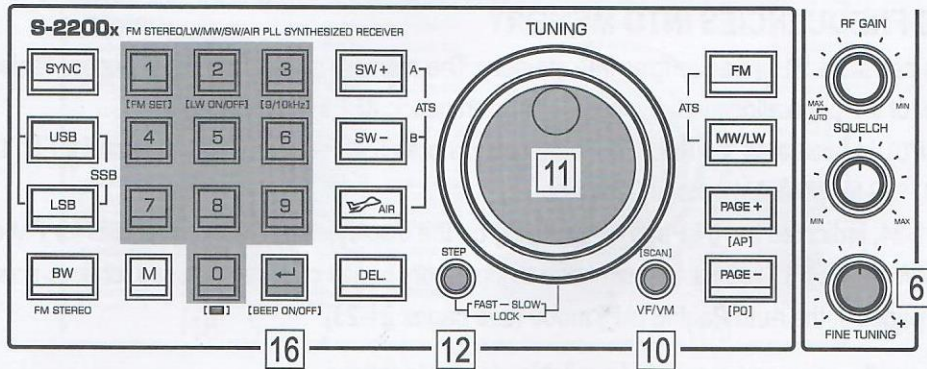

Manual Tuning

In VF mode, select the frequency band and then use the main tuning knob [11] and fine tuning knob [6] to search for your desired stations.

Tip: When tuning for FM, MW/LW and SW broadcasts, adjust the tuning speed of the main tuning knob with the [STEP] button [12]. When >>> is displayed, this indicates that fast tuning has been selected. When > is displayed, slow tuning has been selected. *This option is not available for AIR and SSB tuning.

	FM	LW	MW (AM)	SW	AIR*	SSB*
FAST	0.1 MHz**	9 kHz	9 / 10 kHz	5 kHz	0.025 MHz	1 kHz
SLOW / FINE	0.01 MHz	1 kHz	1 kHz	1 kHz	0.001 MHz	0.01 kHz

**0.05 MHz in 87.5-108 MHz range when MW step is set to 9kHz.

Auto Scan

In VF mode, select the frequency band and then press and hold the [VF/VM] (SCAN) button [10]. The device will automatically scan the entire frequency band for available stations. When a station is found it will stay there for about 5 seconds before continuing the search. When you find a station of your liking and wish to stop the auto scan feature, quick press any button except [DEL.] [15] and [M] [18].

Direct Keypad Entry

In VF mode, quick press the numeric keys [0 - 9] (followed by [←] [16] if necessary) to directly enter a station frequency. For example, enter [2][7][5][0][←] in sequence for listening to shortwave frequency 2750 kHz, or press [1][8][5][5][7] for listening to shortwave frequency 18557 kHz.

Notes:

- Shortwave (SW), medium wave (MW) and longwave (LW) frequencies are entered in kilohertz (kHz), for example, 16875 kHz, 850 kHz, or 189 kHz.
- FM and AIR frequencies are entered in megahertz (MHz), for example 101.5 MHz or 123.580 MHz. Ignore the decimal point when inputting frequency numbers. For example, enter [1][0][1][5] for 101.5 MHz.
- If the entered frequency is not within the covering range, the error "Err" symbol will be displayed.

STORING FREQUENCIES INTO MEMORY

This device can store 9150 frequencies into memory. The memory is divided into 25 pages. Table 1 provides an overview of the page allocation and number of storage locations available.

- 1) Page 0 (P0), indicated as "00 Page" on the display, stores 850 frequencies: 100 each for FM, LW, AIR and SSB, 150 for MW (AM) and 300 for SW.
- 2) Pages 01-24, indicated as "01 Page" - "24 Page" on the display, store 100 frequencies for FM and LW, 900 for MW (AM) and 7200 for SW. MW and SW memory pages can also be used for time-specific memory pages in the Auto Paging (AP) mode (see pages 21-23).

Table 1: Page allocation and number of available storage locations.

		AIR	FM	SW	MW (AM)	LW	SSB
Page allocation and storage locations	Page 00	100	100	300	150	100	100
	Page 01 - 24	--	100	24 x 300 Page 01: 300 Page 02: 300 Page 03: 300 ⋮ Page 24: 300	6 x 150 Pages 01-04: 150 Pages 05-08: 150 Pages 09-12: 150 Pages 13-16: 150 Pages 17-20: 150 Pages 21-24: 150	100	--

Notes:

- For FM and LW, memory pages 01-24 are duplicates of one another. A frequency stored in one page is also stored in all other pages.
- MW pages 01-24 are divided into 6 sections. A frequency stored in one page of a section is also stored in the other pages of that section. SW pages 01-24 are divided into 24 sections. In AP mode, these sections correspond to specific time periods. See Table 2 for an overview and pages 21-23 for further details.

Table 2: Allocation of time-specific MW and SW memory pages in AP mode.

Medium Wave (AM)		Shortwave (SW)	
Time Period	Page	Time Period	Page
01:00 - 04:59	01 - 04	01:00 - 01:59	01
05:00 - 08:59	05 - 08	02:00 - 02:59	02
09:00 - 12:59	09 - 12	⋮	⋮
13:00 - 16:59	13 - 16	22:00 - 22:59	22
17:00 - 20:59	17 - 20	23:00 - 23:59	23
21:00 - 00:59	21 - 24	00:00 - 00:59	24

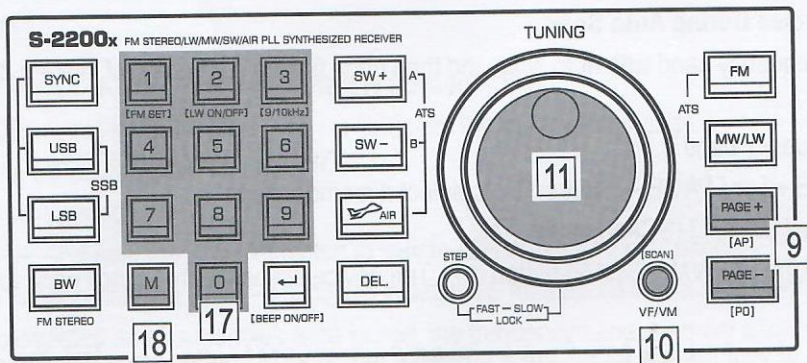

Storing Frequencies Manually

- 1) In VF mode, tune into a frequency.
- 2) Quick press the memory [M] button **18**, " PRESET " flashes in the top right corner of the display.
- 3) Quick press the [PAGE +] or [PAGE -] button **9** to select a memory page.
- 4) Quick press the [M] button to confirm the memory page, " PRESET " flashes in the top right corner of the display and indicates the first available storage location in the selected memory page.
- 5) If desired, change the memory location by rotating the main tuning knob **11**.
- 6) Quick press the [M] button to confirm the memory location.

Notes:

- Use this method to store SSB frequencies into memory. Stored SSB details include USB/LSB and frequency information, but no frequency details smaller than 1 kHz.
- Steps 3 and 4 can be omitted for SSB and AIR frequencies, which are only available for storage in Page 00.
- When storing an MW (AM) frequency into memory pages 01-24, it will be stored in all other pages that belong to the same time period, as indicated in Table 2 on page 14. These time periods are used in AP mode when recalling frequencies (see also pages 21-23).
- When storing an SW frequency into memory pages 01-24, it will be recalled in AP mode during the corresponding time period, as indicated in Table 2 on page 14.

Storing Frequencies During Auto Scan

You can tune a frequency band with auto scan and then upon finding something of interest decide to store it into memory.

- 1) Select the frequency band.
- 2) Use the [PAGE +] or [PAGE -] button **[9]** to select a memory page.
- 3) Quick press the [VF/VM] (SCAN) button **[10]**.
- 4) Press and hold the [VF/VM] (SCAN) button **[10]**. The device scans the frequency band for available stations.
- 5) When a station of your liking is found, quick press the memory [M] button twice **[18]**; the device continues to scan for the next available station.
- 6) To stop the auto scan feature, gently rotate the main tuning knob **[11]**.

Notes:

- For storing SSB frequencies, please use the manual storing method (see page 15).
- Auto scan tunes the frequency band in the direction of the last used tuning direction (upwards/downwards). If you need to change the direction, stop the auto scan, rotate the main tuning knob in your preferred direction and then restart auto scan.
- When storing an MW (AM) frequency into memory pages 01-24, it will be stored in all other pages that belong to the same time period, as indicated in Table 2 on page 14. These time periods are used in AP mode when recalling frequencies (see also pages 21-23).
- When storing an SW frequency into memory pages 01-24, it will be recalled in AP mode during the corresponding time period, as indicated in Table 2 on page 14..

Auto Tuning Storage (ATS)

Automatically tune into and store FM, LW, MW, SW and AIR frequencies.

Operation for FM, MW/LW and AIR:

- 1) Select the frequency band.
- 2) Use the [PAGE +] or [PAGE -] button **[9]** to select an (empty) memory page.
- 3) Quick press the [VF/VM] (SCAN) button **[10]**.
- 4) Press and hold the corresponding band button ([FM], [MW/LW] or [AIR]) until "PRESET" flashes and the frequency starts running.
- 5) After ATS is completed and frequencies were stored, the frequency band, memory page and the number of stored frequencies will be displayed, as shown in the figure above. To stop the ATS process before it has finished, gently rotate the main tuning knob **[11]**.

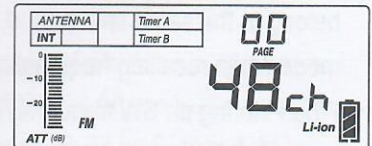

Operation for SW:

- 1) Quick press [SW +] or [SW -] to select the SW frequency band.
- 2) Use the [PAGE +] or [PAGE -] button **[9]** to select an (empty) memory page.
- 3) Quick press the [VF/VM] (SCAN) button **[10]**.
- 4) There are two ATS modes for SW:
 - Mode A: Press and hold the [SW +] button to initiate ATS within all meter bands.
 - Mode B: Press and hold the [SW -] button to initiate ATS for stations within the selected meter band.
- 5) After ATS is completed and frequencies were stored, the frequency band, memory page and the number of stored frequencies will be displayed. To stop the ATS process before it has finished, gently rotate the main tuning knob **[11]**.

Tips:

- Airband is scanned continuously for 30 cycles. After the scan is completed, the frequencies are automatically sorted.
- After ATS is completed, rotate the main tuning knob to view all stations that were stored during the scan.
- ATS (except in SW mode B) replaces previously stored radio stations within a memory page. To prevent this from happening, please select an empty memory page before initiating ATS or choose manual or auto scan storage to add new stations to a memory page that already contains stored stations.
- When storing an MW (AM) frequency into memory pages 01-24, it will be stored in all other pages that belong to the same time period, as indicated in Table 2 on page 14. These time periods are used in AP mode when recalling frequencies (see also page 23).
- When storing an SW frequency into memory pages 01-24, it will be recalled in AP mode during the corresponding time period, as indicated in Table 2 on page 14.

Optimizing ATS Frequency Storage Results

The storage results of Auto Tuning Storage (ATS) depend on a variety of factors:

- Longwave (LW) and Medium Wave (MW) signals are directional. Adjusting the direction of the rotatable antenna can improve the reception.
- Due to the nature of radio wave propagation, the number of longwave and medium wave broadcasts received at night is greater than during the day.
- For shortwave, radio wave propagation is affected by ionospheric changes (different time periods in the morning, noon, and evening, different seasons, sunspot cycles, etc.).
- Broadcasts may only take place during specific hours of the day.
- The receiving environment (geographical or local sources of interference) and the receiving equipment (such as the antenna) impact the results.

By adjusting the capture threshold levels of the signal strength and signal-to-noise ratio, it is possible to try and improve the auto tuning and storage results for LW, MW (AM), SW and FM under different signal receiving conditions.

If the threshold levels for the signal strength and signal-to-noise ratio are set high, the capture sensitivity is low, which means that broadcasts with weak signals will be missed. If the threshold levels for the signal strength and signal-to-noise ratio are set low, the capture sensitivity is high, which will result in radio noise mistakenly being regarded as radio signals and are stored into memory.

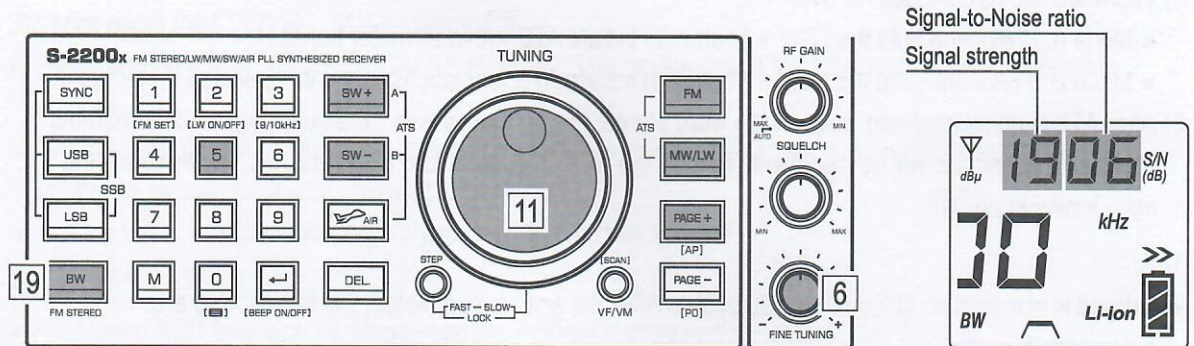

Setting the Signal Capture Sensitivity of Auto Tuning Storage (ATS)

- 1) Turn on the device and select a frequency band (FM, LW, MW, or SW).
- 2) Press and hold the [BW] button [19] until the signal strength value flashes.
- 3) Rotate the main tuning knob [11] to adjust the signal strength value.
- 4) Rotate the [FINE TUNING] knob [6] to adjust the signal-to-noise ratio value.
- 5) Quick press the [BW] button [19] to confirm.

Note: Adjustments to the signal capture sensitivity are band specific.

Auto Sorting Memory

This feature can automatically organize all frequencies that have been stored into memory. Within a memory page, duplicate frequencies are deleted and the remaining frequencies are sorted.

- 1) Turn the device off.
- 2) Press and hold the [] (0) button until the memory page number "POCJ" - "24CJ" on the display starts running.

LISTENING TO STORED FREQUENCIES (VM MODE)

Recalling frequencies that have been stored into memory is done in the VM (memory) mode. You can enter the memory using the [VF/VM] (SCAN) [10], [PAGE +] or [PAGE -] button [9]. If no frequencies have been stored for the selected frequency band and memory page, the display shows "0 ch" and the device remains in the frequency tuning (VF) mode. If there are stored frequencies, the display shows how many. For example, in the figure below, the display indicates that 48 FM frequencies are stored in memory page 00.

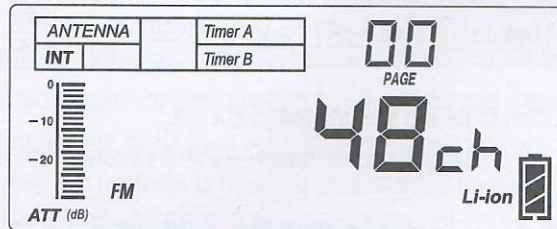

VM mode

Recalling Stored Frequencies Manually

- 1) Select the frequency band (FM, LW, MW, SW, AIR) or mode (SSB).
- 2) Quick press [PAGE +] or [PAGE -] [9] to automatically enter VM mode and select a memory page (for AIR and SSB, only page 00 is available). If the display shows "0 ch", the selected memory page has no stored stations and the device remains in VF mode.
- 3) Rotate the main tuning knob to select a memory, or use the numeric keys to directly enter the preset station number followed by a quick press of the [←] button to confirm.

Notes:

- If the selected page does not contain any stored frequencies, the device remains in VF mode.
- If you find yourself in pages 01-24 and wish to return to page 00, press and hold the [PAGE -] (P0) button.
- If the display shows " - - - " after entering a preset station number with the numeric keys, this indicates that there is no stored frequency at that location.

Recalling Stored Frequencies by Scanning a Memory Page

This device can auto scan a memory page, staying on each stored frequency for about 5 seconds.

- 1) Select the frequency band (FM, LW, MW, SW, AIR) or mode (SSB).
- 2) Quick press [PAGE +] or [PAGE -] [9] to automatically enter VM mode and select a memory page (for AIR and SSB, only page 00 is available). If the display shows "0 ch", the selected memory page has no stored stations and the device remains in VF mode.
- 3) Press and hold the [VF/VM] (SCAN) button [10] until "PRESET" flashes in the upper right corner of the display. The device scans all stored frequencies within the selected memory page.
- 4) To stop scanning, quick press any button except [DEL.] [15] and [M] [18].

DELETING FREQUENCIES FROM MEMORY

Deleting a Single Frequency

- 1) Select the frequency band (FM, LW, MW, SW, AIR) or mode (SSB).
- 2) Quick press [PAGE +] or [PAGE -] [9] to enter VM mode and select a memory page (for AIR and SSB only page 00 is available).
- 3) Rotate the main tuning knob [11] to select the frequency to be deleted.
- 4) Press and hold the [DEL.] button [15] until "dEL" and "PRESET" flash on the display.
- 5) Quick press the [DEL.] button to delete the unwanted station.

Note: If the [DEL.] button is not pressed for confirmation within 3 seconds, the delete mode is cancelled.

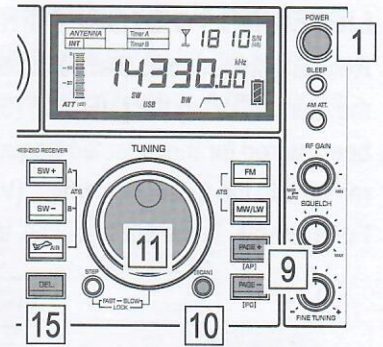

Deleting Frequencies During Memory Page Scan

This device can auto scan all stored frequencies within a memory page, staying on each frequency for about 5 seconds, and giving you the opportunity to delete any unwanted frequencies.

- 1) Select the frequency band (FM, LW, MW, SW, AIR) or mode (SSB).
- 2) Quick press [PAGE +] or [PAGE -] [9] to enter VM mode and select a memory page (for AIR and SSB only page 00 is available).
- 3) Press and hold the [VF/VM] (SCAN) button [10] until "PRESET" flashes in the upper right corner of the display. The device scans all stored frequencies within the selected memory page.
- 4) Upon finding an unwanted station, press the [DEL.] button [15]. No confirmation is required and scanning continues immediately.
- 5) To stop the memory scan, gently rotate the main tuning knob [11].

Deleting All Stored Frequencies in a Memory Page

- 1) Select the frequency band (FM, LW, MW, SW, AIR) or mode (SSB).
- 2) Quick press [PAGE +] or [PAGE -] [9] to enter VM mode and select a memory page (for AIR and SSB only page 00 is available).
- 3) Press and hold the [DEL.] [15] button until "dEL" and "ALL" flash on the display.
- 4) Quick press the [DEL.] button to confirm. All memories from the selected frequency band and memory page are deleted.

Note: If the [DEL.] button is not pressed for confirmation within 3 seconds, the delete mode is cancelled.

Deleting All Stored Frequencies From Memory

- 1) Turn the device off.
- 2) Press and hold the [DEL.] [15] button until "dEL" and "ALL" flash on the display.
- 3) Quick press the [POWER] button [1] to confirm. "dEL" is displayed for a few seconds while the memory is cleared of all stored frequencies.

AUTO PAGING (AP) MODE: TIME-SPECIFIC MEMORIES FOR MW (AM) AND SW

Because broadcasts in the MW (AM) and SW bands may only be available during a certain time of day, you can use ATS in Auto Paging (AP) mode to automatically search and store frequencies in the time-specific memory pages 01-24 as indicated in Table 2 on page 14. Subsequently, when using AP to recall frequencies, it will only show the frequencies that are stored in the memory pages of the current time period. In a way, you can then use pages 01-24 to create a broadcast frequency schedule.

For example:

- Medium Wave (AM) frequencies stored with AP ATS between 09:00 - 12:59 are automatically stored on pages 09, 10, 11, and 12, frequencies stored between 13:00 - 16:59 are stored on pages 13, 14, 15 and 16. When using AP to recall frequencies at 12:30, it will only show those frequencies stored in the 09:00 - 12:59 time period. In this way, it is possible to create 6 time-specific memories for MW (AM).
- Shortwave (SW) frequencies stored with AP ATS between 11:00 - 11:59 are automatically stored on page 11, frequencies stored between 17:00 - 17:59 are automatically stored on page 17. When using AP to recall frequencies at 17:20, it will only show those frequencies stored on page 17. In this way, it is possible to create 24 time-specific memories for SW.

Using AP ATS to Create Time-Specific Memories for MW (AM) and SW

Please make sure that the clock of your S-2200x has been correctly set before using this feature (see page 8).

- 1) Select the MW or SW frequency band.
- 2) Press and hold the [PAGE +] (AP) button [9]. "AP" is displayed behind the frequency, indicating that the AP mode is entered, as shown in the figure on the right.
- 3) Press and hold the related band button ([MW/LW], [SW +] or [SW -]) to initiate the AP auto tuning and storage (ATS) feature.
- 4) When AP ATS is completed, the frequency band, time-specific page number, and the number of stored frequencies are displayed. To stop AP ATS before it has finished, rotate the main tuning knob.

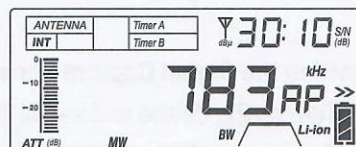

In the example on the right, "20ch", "MW" and "11" indicate that 20 medium wave broadcast frequencies were stored on page 11 during AP ATS that took place between 11:00 - 11:59. Because 11:00 - 11:59 belongs to the 09:00 - 12:59 time interval (see Table 2 on page 14), all 20 medium wave frequencies are available on memory pages 09, 10, 11, and 12.

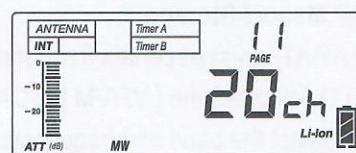

Notes:

- There are two AP ATS modes for SW:
 - Mode A: Press and hold the [SW +] button to scan and store broadcasts within all meter bands.
 - Mode B: Use the [SW -] button to select a meter band, then press and hold [SW -] to initiate ATS.
- AP ATS (except in SW mode B) will replace any previously stored frequencies that are already available in

the time-specific memory pages (pages 01-24). For example, if MW memory page 11 already contains frequencies that were stored with other storage methods (manual storage, auto scan storage, ATS) then these will be replaced when performing AP ATS for MW during the 09:00 - 12:59 time interval.

- It is possible to perform AP ATS for FM and LW, but this will only replace the frequencies that are already stored in memory pages 01-24 and not create time-specific memories. To automatically tune and store FM and LW memories in pages 01-24, please use Auto Tuning Storage (ATS) as indicated on page 16.
- If there is a time period change during AP ATS, the device will stop scanning and delete all frequencies stored in the previous time period, after which it automatically re-scans and stores the frequencies into the new time period.

Optimizing ATS Frequency Storage Results in Auto Paging (AP) Mode

The factors influencing the results of ATS in AP mode are the same as described for ATS on page 17. By adjusting the capture threshold levels of the signal strength and signal-to-noise ratio, it is possible to try and improve the ATS results in AP mode for MW (AM) and SW under different signal receiving conditions.

If the threshold levels for the signal strength and signal-to-noise ratio are set high, the capture sensitivity is low, which means that broadcasts with weak signals will be missed. If the threshold levels for the signal strength and signal-to-noise ratio are set low, the capture sensitivity is high, which will result in radio noise mistakenly being regarded as radio signals and stored into memory.

Setting the Signal Capture Sensitivity of AP ATS

- 1) Turn on the device and select the MW or SW frequency band.
- 2) Press and hold the [PAGE +] (AP) button to enter the AP mode.
- 3) Press and hold the [5] key until the signal strength value flashes.
- 4) Rotate the main tuning knob [11] to adjust the signal strength value.
- 5) Rotate the [FINE TUNING] knob [6] to adjust the signal-to-noise ratio value.
- 6) Quick press the [5] key to confirm.

AP Manual Storage

If AP ATS missed certain frequencies (e.g. due to interference), then it is possible to add these manually:

- 1) Quick press the [VF/VM] (SCAN) button [10]. The frequency flashes twice and enters VF mode.
- 2) Select the band and frequency.
- 3) Quick press the [M] button [18]. "PRESET" flashes in the top right corner of the display.
- 4) Press and hold the [PAGE +] (AP) button. "AP" and "PRESET" flash on the display.
- 5) Quick press the [M] button [18] to confirm.

Recalling AP Time-Specific MW (AM) and SW Memories

- 1) Select the MW (AM) or SW frequency band.
- 2) Press and hold the [PAGE +] (AP) button to enter the AP mode.
- 3) Rotate the main tuning knob to select a stored frequency. Alternatively, press and hold the [VF/VM] (SCAN) button [10] to perform a memory scan. The device scans all stored frequencies of the selected band in the current time period, staying on each frequency for 5 seconds before continuing to the next one. To stop the scan and listen to a memory, quick press any button except [DEL.] [15] and [M] [18].

Tips:

- If “**ch**” is displayed after entering MW or SW in AP mode, it means that there are no previously stored frequencies in the current time period (see Table 2 on page 14 for an overview). Press and hold the frequency band button to auto tune and store frequencies in the current AP time period, or quick press the [VF/VM] (SCAN) button to exit AP mode.
- While in AP mode, it is possible to recall FM and LW frequencies that are stored in memory pages 01-24.

ANTENNA SIGNAL ATTENUATION

When listening to longwave (LW), medium wave (MW) or shortwave (SW) radio and experiencing strong signal overloading, quick press the [AM ATT.] button **3** to attenuate the input signal by -10dB, -20dB or 0dB (no attenuation). Experiment with this control to see how it works best with the signals that you listen to.

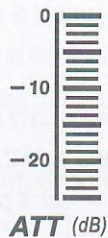

no signal attenuation

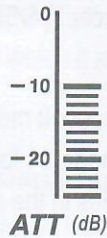

10dB signal attenuation

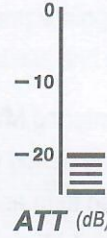

20dB signal attenuation

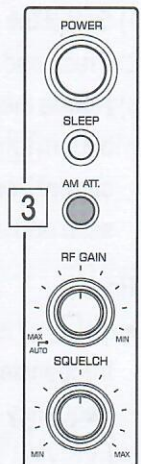

RF GAIN CONTROL

When listening to longwave (LW), medium wave (MW) or shortwave (SW) radio, use the RF Gain control knob [RF GAIN] **4** to adjust the gain for signals of different strengths and obtain the best reception.

- Automatic gain control: Turn the knob counterclockwise until it makes a “click” sound, indicating that the gain control is set to AUTO.
- Manual gain control: Turn the knob clockwise to reduce gain, counterclockwise to increase gain. Using it manually may improve the rejection of interference from adjacent frequencies that may interfere, especially on shortwave.

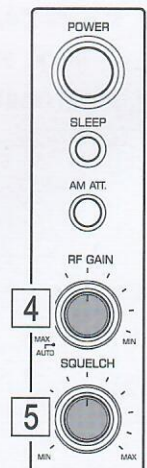

SQUELCH CONTROL

Using the squelch control knob may reduce or suppress background noise when listening to longwave (LW), medium wave (MW), shortwave (SW) and airband. Turn the [SQUELCH] knob **5** clockwise to increase the squelch level, turn it counterclockwise to lower the squelch level.

Tip: If the squelch level is adjusted too high, weak radio signals will be missed. Turn off the squelch control function completely by turning the [SQUELCH] knob fully counterclockwise until the knob makes a “click” sound.

SSB (SINGLE SIDEBAND) TUNING

When receiving longwave, medium wave (AM) and shortwave broadcasts, you can activate the SSB mode to receive particular signals like for example amateur radio communication and Morse Code, but it can also help to mitigate interference.

Quick press the [LSB] (Lower Sideband) or [USB] (Upper Sideband) button **20** to enable the sideband. Quick press again to disable SSB.

Tip: In SSB, quick press the [SW +] or [SW -] button repeatedly to change meter bands: 160m / 80m / 60m / 40m / 30m / 24m / 20m / 17m / 15m / 12m / 10m.

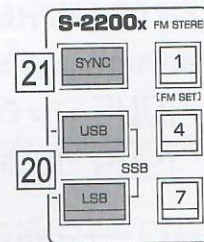

SYNCHRONOUS DETECTION (SYNC)

When listening to longwave, medium wave (AM) and shortwave broadcasts, turning on synchronous detection may reduce noise interference, eliminate distortion caused by local fading during signal transmission, and suppress interference caused by adjacent stations.

Enable/Disable SYNC detection:

- 1) Quick press the [SYNC] button **21**, the display shows " SYNC " and the radio enters the synchronous detection mode.
- 2) Quick press the [USB] or [LSB] button **20** to select Upper Sideband or Lower Sideband SYNC detection.
- 3) To disable, quick press the [SYNC] button, " SYNC " disappears from the display.

Note: Enabling the SYNC detector does not always reduce interference.

AM BANDWIDTH SELECTION

Quick press the [BW] button **19** repeatedly, or press and then rotate the [FINE TUNING] knob **6**, to select different bandwidths to enhance the intelligibility of longwave, medium wave, shortwave, airband and SSB signals.

Selectable bandwidths are:

LW/MW: 1.0, 2.3, 3.5, 5.0 and 9.0kHz.

SW/AIR: 1.0, 2.3, 3.5, 5.0 and 6.0kHz.

SSB: 0.5, 1.2, 2.3, 3.0 and 4.0kHz.

- Wider bandwidth: Has better audio fidelity when receiving strong signals or local stations.
- Narrower bandwidth: Limits interference from adjacent strong signals and background noise, thereby especially suitable for receiving weak and distant stations.

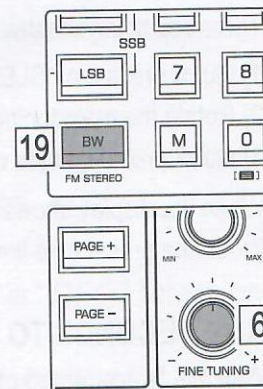

FM DE-EMPHASIS TIME CONSTANT

While receiving FM broadcasts, long press the [4] button to adjust the de-emphasis setting to 50 μ s or 75 μ s.

“**50 μ S**” : For Europe, Australia, Japan (and most other locations).

“**75 μ S**” : For the Americas and South Korea.

FM STEREO/MONO SELECTION

Quick press the [BW] (FM STEREO) button **19** . If the device detects that the FM signal is in stereo the display shows “ Stereo ” behind the FM band indicator.

Quick press the [BW] (FM STEREO) button again to return to mono listening.

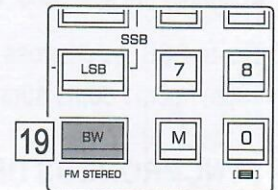

Tips:

- When the FM signal is broadcasted in mono, or broadcasted in stereo but the signal received is weak, the audio output is in mono and “ Stereo ” is not displayed.
- When listening to FM from the built-in speaker, or when listening to FM broadcasts with a weak signal, it is recommended to listen in mono.

TREBLE & BASS CONTROL

Rotate the [TREBLE] **23** and [BASS] **24** knobs to adjust the treble (higher frequencies) and bass (lower frequencies) of the speaker sound.

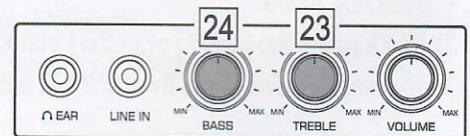

SETTING THE SLEEP TIMER

The sleep timer enables the device to play any length of time from 1 – 120 minutes and then turn off.

- 1) Quick press the [SLEEP] button **2** .
- 2) Rotate the main tuning knob to select a power-off timer of 1 – 120 minutes.
- 3) Quick press [←] to confirm, or wait for 2 seconds for the system to auto confirm.

When the display shows “ **SLEEP** ”, this indicates that the sleep timer has been activated.

When the preset time limit is reached, the radio automatically turns off.



ADD SECONDS TO THE CLOCK

With the device turned off, press and hold the [8] button to add seconds to the clock. Press and hold the button again to hide the seconds from the clock.

ACTIVATING / DEACTIVATING THE ALARM

There are two independently programmable alarms to turn on the device at a specific time. Quick press [TIMER A] or [TIMER B] to activate the alarm. The alarm “ **⏰** ” icon is shown on the display to indicate that the device will turn on at the preset time. Quick press again to deactivate the alarm setting.

SETTING THE ALARM TIME

- 1) Press and hold the [TIMER A] button **[29]**, the alarm time in the upper right corner of the display will start to flash.
- 2) While still flashing, use the numeric keys to enter the time (4 digits in total). For example, 8:39 is entered as [0], [8], [3], [9].
- 3) Now rotate the main tuning knob to set the duration after which the device should turn off (01 - 60 minutes).
- 4) Quick press [TIMER A] to confirm the setting, or wait for 2 seconds until it auto confirms. The alarm "🔊" icon for Timer A is shown on the display.

For setting [TIMER B] you can follow the same steps.

Tips:

- Once the alarm time is reached, the radio turns on and stays on for as long as the alarm duration (01 – 60 minutes) was set. To turn off the device during the alarm playtime, quick press the red [POWER] button twice.
- If you wish to change the radio frequency during the alarm playtime, quick press the red [POWER] button. This will deactivate the alarm after which you can adjust the frequency.

SETTING A RADIO FREQUENCY FOR THE ALARM

- 1) Turn on the device, select the frequency you want to use as the alarm and adjust the volume to an appropriate level.
- 2) Quick press the [M] button **[18]**, the memory preset location will flash.
- 3) While still flashing, quick press the [TIMER A] or [TIMER B] button **[29]**, the alarm "🔊" icon will flash.
- 4) While still flashing, quick press the [←] button **[16]**, "🔊" stops flashing and the setting is completed.

ALARM AUTO CLEARANCE

If the device is not used (turning knobs, pressing buttons) for three days, the alarm settings are automatically cleared. To keep the alarm settings, you can turn off the automatic clearance feature.

- 1) Turn off the device.
 - 2) Press and hold the [VF/VM] (SCAN) button for about 10 seconds, until "ON" or "OFF" appears on the display.
- "ON": The alarm auto clearance feature is turned on. Alarm settings are cleared after 3 days of not using the device.
- "OFF": The alarm auto clearance feature is turned off. Alarm settings are retained after 3 days of not using the device.

ALARM SNOOZE FUNCTION

When the alarm sounds, quick press the [DISPLAY/SNOOZE] button **31** to temporarily turn off the alarm. The alarm will go off again after 5 minutes. To disable this feature while still snoozing, quick press the red [POWER] button.

USING HEADPHONES

The headphone socket **26** is located on the lower left front of the radio and is labeled EAR. Plug in headphones (32-300Ω) using a Φ 3.5 mm (1/8 inch) stereo plug.

Warning! Lower the volume before plugging in your headphones. To avoid hearing damage, do not use headphones for long periods of time or at high volumes.



AUDIO INPUT (LINE IN)

The audio input socket is located on the lower left front of the radio and is labeled LINE IN **25**. You can use this device as an active speaker for an external audio source. Use a stereo audio cable with a Φ 3.5 mm (1/8 inch) plug to connect the [LINE IN] socket to the audio output socket of the source. Adjust the volume, treble and bass with the knobs of this device. The built-in speaker output is mono and the headphone output is stereo.

AUDIO OUTPUT (LINE OUT)

The audio output sockets are located at the rear of the radio and are labeled LINE OUT **37**. You can use this device as a radio tuner for your home audio system.

- 1) Use a stereo audio cable to connect the [LINE OUT] L (left channel) and R (right channel) sockets of this device to the stereo audio input of the power amplifier.
- 2) Lower the volume on this device to a minimum (the volume level is controlled by the power amplifier).

Note: The treble and bass controls on this device are disabled while feeding audio through the [LINE OUT] socket.

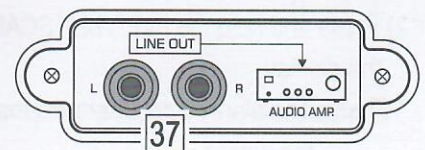

DISPLAY OPTIONS

- With the device off, quick press the [DISPLAY/SNOOZE] button **31** repeatedly to view the alarm time of "Timer A" and "Timer B".
- With the device on, quick press the [DISPLAY/SNOOZE] button **31** repeatedly to view the signal strength/signal-to-noise ratio, the memory location (preset) of the current frequency (in VM mode, but not in AP mode), the alarm time of Timer A and Timer B, and the current clock time.
- With the device on, quick press the [TIME] button **30**, the display will show the current time. Quick press again to return to frequency display.

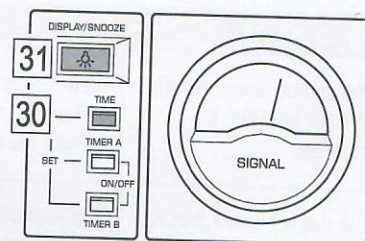

DISPLAY BACKLIGHT

Press and hold the [] (DISPLAY/SNOOZE) button **31** to set your preference:

- "On": Backlight is set to always-on. When turning the device off, the backlight turns off as well. When pressing a button or rotating a tuning knob the backlight turns back on and is set to always-on.
- "OFF": Backlight turns on when a button or tuning knob is operated and turns off after 5 seconds.

ACTIVATE / DEACTIVATE "BEEP" SOUND

Press and hold the [] (BEEP ON/OFF) button **16** to activate or deactivate the operation beep sound:

- "On": Beep sound is heard when using the keypad to enter a frequency, alarm or clock time and for (most) function buttons.
- "OFF": Beep sound is turned off.

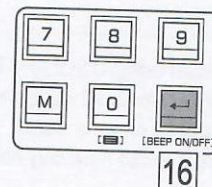

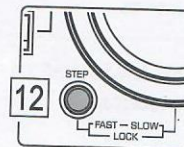

KEYLOCK

To activate the keylock, press and hold the [STEP FAST-SLOW] (LOCK) button **12**. The lock "  " icon is displayed and the buttons and tuning knobs are disabled. Press and hold the button again to unlock.



Troubleshooting

ISSUE	POSSIBLE CAUSE / SOLUTION
The display does not turn on after installing the batteries.	Batteries have no power, are installed incorrectly, or the battery switch is not in the correct position. <ul style="list-style-type: none"> ● Replace, charge or reinstall the batteries. ● Push the battery switch (located in the 18650 batteries compartment) in the correct position.
The display works, but the device does not power on.	The keylock is activated, disabling all buttons and tuning knobs. <ul style="list-style-type: none"> ● Press the [STEP FAST-SLOW] (LOCK) button until the "  " disappears from the display.
When turned on, the buttons and knobs do not respond.	The keylock is activated, disabling all buttons and tuning knobs. <ul style="list-style-type: none"> ● Press the [STEP FAST-SLOW] (LOCK) button until the "  " disappears from the display.
Unable to charge the 18650 batteries, or the batteries drain quickly.	Battery switch is not in the correct position, there is an issue with the charger, one or both batteries are not in good condition. <ul style="list-style-type: none"> ● Push the battery switch in the correct position. ● Check the charger and charging cable. ● Replace the batteries.
Radio auto turns off while listening.	Batteries have no power or the sleep timer was activated. <ul style="list-style-type: none"> ● Replace or charge the batteries. ● Turn the radio back on without setting the sleep timer.
When using ATS or AP ATS, some broadcast signals are skipped or some stored frequencies have only noise.	The radio signal is too weak, there is strong interference, or MW (AM) tuning steps are not set accurately. <ul style="list-style-type: none"> ● Search and store stations manually. ● Adjust the length and direction of the antenna or change to a different location and try again. ● Try adjusting the signal capture sensitivity of ATS and AP ATS (see pages 18 and 22).
Poor MW (AM) auto tune and storage results while using in North or South America.	MW (AM) stations are spaced at 10 kHz in the Americas, the device may be set to 9 kHz tuning steps. <ul style="list-style-type: none"> ● Turn off the device, then press and hold the [3] button to change the MW tuning step to 10 kHz (see also page 8).
Only few FM stations can be received.	FM frequency range may not be set correctly for your country. <ul style="list-style-type: none"> ● Find information about the FM frequency coverage in your country. Turn off the radio, press and hold the [1] button to select a suitable range.
In AP mode, the tuning knob does not respond.	There are no stored frequencies for the current time period. <ul style="list-style-type: none"> ● Press and hold the [PAGE +] (AP) button to perform AP ATS to scan and store frequencies, or quick press the [VF/VW] (SCAN) button to exit the AP mode.
Audio quality is not good when listening to LW, MW (AM) and SW.	The AM bandwidth is too narrow, or perhaps Single Sideband (SSB) is enabled. <ul style="list-style-type: none"> ● Press the [BW] button repeatedly to change to a wider bandwidth. ● Exit SSB using the corresponding sideband (USB/LSB) buttons.
When the alarm goes off the radio broadcast is only noise.	Alarm preset radio frequency was not properly set, or there are no broadcasts at that time. <ul style="list-style-type: none"> ● Assure that receiving a broadcast is possible at the alarm time and the location where the device is placed.

S-2200x Specifications

Station Memory: 9150 in total

Frequency Range:

LW: 50 - 522kHz (MW 9kHz setting; see also page 8)
100 - 519kHz (MW 10kHz setting; see also page 8)

MW (AM): 522 - 1620kHz (MW 9kHz setting; see also page 8)
520 - 1710kHz (MW 10kHz setting; see also page 8)

SW: 1621 - 29999kHz (MW 9kHz setting; see also page 8)
1711 - 29999kHz (MW 10kHz setting; see also page 8)

FM: 64 - 108MHz
76 - 108MHz
87 - 108MHz
87.5 - 108MHz

AIR: 118 - 137MHz

Sensitivity:

LW (S/N=26dB) < 3mV/m
MW (S/N=26dB) < 1mV/m
SW (S/N=26dB) < 20 μ V
SSB (S/N=10dB) < 1 μ V
FM (S/N=30dB) < 3 μ V
AIR (S/N=26dB) < 5 μ V

Selectivity:

LW > 40dB
MW > 40dB
SW > 40dB
FM > 65dB
AIR > 60dB

S-2200x Specifications (continued)

S/N Ratio:

LW	> 40dB
MW	> 40dB
SW	> 45dB
FM	> 60dB
AIR	> 60dB

SYNC Lock Range: +/- 1kHz

IF Frequency:

AM:	1st IF: 55.845MHz, 2nd IF: 10.7MHz, 3rd IF (DSP): 45kHz
FM:	128kHz

FM Stereo Crosstalk: 35dB
(headphones)

Max. Output Power: 1500mW

Shutdown Current: < 100 μ A

Speaker: ϕ 4", 8 Ω , 2W

Headphone Input: ϕ 3.5mm (1/8 inch), 32 Ω - 300 Ω

Power Supply: 6V (4 x D-type (R20/UM1) 1.5V batteries) or
8.4V (2 x 4.2V (3.7V nominal) 18650 Li-ion batteries)

Charging: DC 5V \equiv 2A, USB type-C socket

Dimensions: Approx. 372 (W) x 183 (H) x 153 (D) mm
(excl. antenna and handle)

Weight (excl. battery): Approx. 2.43kg

TECSUN



TECSUN ELECTRONIC IND. LTD.

Address: Unit 11, 13/F, Block A, Hoi Luen Ind. Ctr., 55 Hoi Yuen Road,
Kwun Tong, Kowloon, Hong Kong.

E-mail: tecsun@on-nets.com

Website: www.tecsun.com.cn www.tecsun-audio.com

V150724